

Function Fittings

**Flow Control Regulators**

**Piloted Function Fittings**

**Non-Return Valves**

**LIQUIfit®**

**Pressure Fittings**

**Other Function Fittings**

**Silencers**



# Function Fittings

## Flow Control Regulators

(P. 4-6)



**Function:** controls the speed of the cylinder rod  
**Materials:** polymer, metal, stainless steel  
**Pressure:** 10 bar  
**Temperature:** 0°C to +70°C  
**Ø metric:** 3 mm to 18 mm  
**Threads:** BSPP, BSPT, metric

## Blocking Fittings

(P. 4-36)



**Function:** provides safety by locking the cylinder piston  
**Materials:** nickel-plated brass, polymer  
**Pressure:** 10 bar  
**Temperature:** -20°C to +70°C  
**Ø metric:** 6 mm to 12 mm  
**Threads:** BSPP, BSPT

## Piloted Non-Return Valves

(P. 4-38)



**Function:** provides safety by locking the cylinder piston  
**Materials:** nickel-plated brass, polymer  
**Pressure:** 10 bar  
**Temperature:** -5°C to +60°C  
**Ø metric:** 6 mm to 12 mm  
**Threads:** BSPP

## Non-Return Valves

(P. 4-40)



**Function:** allows air to pass in one direction only  
**Materials:** polymer, nickel-plated brass  
**Pressure:** 10 bar  
**Temperature:** 0°C to +70°C  
**Ø metric:** 4 mm to 12 mm  
**Threads:** BSPP, BSPT, metric

## Adjustable Non-Return Valves

(P. 4-42)



**Function:** allows air to pass in one direction with an adjustable opening pressure  
**Materials:** FDA chemical nickel-plated brass  
**Pressure:** 12 bar  
**Temperature:** -20°C to +80°C  
**Threads:** BSPP, metric

## LIQUIfit® Non-Return Valves

(P. 4-44)



**Function:** allows fluid to pass in one direction only  
**Materials:** polymer for food applications  
**Pressure:** 10 bar  
**Temperature:** 0°C to +65°C  
**Ø inch:** 1/4" and 3/8"

## Stainless Steel Non-Return Valves

(P. 4-46)



**Function:** allows fluid to pass in one direction only  
**Materials:** stainless steel  
**Pressure:** 0.5 to 40 bar  
**Temperature:** -20°C to +180°C  
**DN :** 10 mm to 25 mm  
**Threads:** BSPP, NPT

## Soft Start Fittings

(P. 4-48)



**Function:** protects the installation at start-up  
**Materials:** polymer, nickel-plated brass  
**Pressure:** 3 to 10 bar  
**Temperature:** -15°C to +60°C  
**Ø metric :** 8 mm to 12 mm  
**Threads:** BSPP

## Pneumatic Sensor Fittings

(P. 4-50)



**Function:** pneumatic or electric output signal, detects end of cylinder rod stroke  
**Materials:** polymer, treated metal  
**Pressure:** 3 to 8 bar  
**Temperature:** -15°C to +60°C  
**Ø metric:** 4 mm  
**Threads:** BSPP, metric

# Function Fittings

## Pressure Regulators/Pressure Reducers (P. 4-52)



**Function:** limits the maximum pressure delivered to pneumatic equipment

**Materials:** polymer, treated metal

**Pressure:** 16 bar (upstream), 8 bar (downstream)

**Temperature:** -15°C to +70°C

**Ø metric:** 4 mm to 10 mm

**Threads:** BSPP

## Snap Connectors (P. 4-56)



**Function:** isolates a circuit without venting the whole system

**Materials:** polymer, nickel-plated brass

**Pressure:** 10 bar

**Temperature:** -20°C to +80°C

**DN** : 5 mm to 7 mm

**Threads:** BSPP

## Manually-Operated Valves (P. 4-58)



**Function:** opens/closes a circuit, with or without venting

**Materials:** polymer, nickel-plated brass, aluminium

**Pressure:** 16 bar, 10 bar

**Temperature:** -10°C to +80°C

**Ø metric:** 4 mm to 10 mm

**Threads:** BSPP, metric

## Metal Quick Exhaust Valves (P. 4-60)



**Function:** increases the return speed of the cylinder

**Materials:** nickel-plated brass, aluminium, stainless steel

**Pressure:** 10 bar

**Temperature:** -20°C to +70°C

**Threads:** BSPP, BSPT, metric

## Silencers (P. 4-62)



**Function:** reduces noise levels

**Materials:** sintered bronze, polyethylene, stainless steel, nickel-plated brass

**Pressure:** 12 bar

**Temperature:** -20°C to +180°C









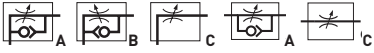

**Ø metric:** 4 mm to 12 mm

**Threads:** BSPP, metric, NPT

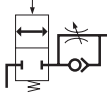
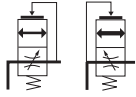
# Selecting Your Function Fitting

<b>Protect Your System</b>	<b>Blocking Fittings</b>	Maintain the load following an emergency stop of a pneumatic system.	Models <b>7880 - 7881 - 7883 - 7885 7886</b>
	<b>Soft Start Fittings</b>	Increase the pressure gradually in order to protect it from potentially damaging shock when a pneumatic system is restarted.	Models <b>7860 - 7861 - 7870 - 7871</b>
	<b>Non-Return Valves</b>	Allow compressed air to flow in one direction, and prevent it from flowing in the other. If the supply is accidentally shut off, the air can only escape in one direction.	Models <b>4890 - 4891 - 4892 - 4895 7930 - 7931 - 7932 - 7984 7985 - 7992 - 7994 - 7995 7996</b>
	<b>Piloted Non-Return Valves</b>	Incorporate 3 functions into one product to protect your system: piloted non-return valve, flow control regulator and manual vent.	Models <b>7892 - 7894</b>
<b>Detect End of Cylinder Rod Stroke</b>	<b>Pneumatic Sensor Fittings</b>	Detect the back pressure drop at the end of stroke to produce a signal (pneumatic or electronic) to allow reciprocation.	Models <b>7818 - 7828</b>
<b>Control and Improve the Performance of Your System</b>	<b>Pressure Regulators</b>	Regulate and stabilise the pressure at a maximum determined value whatever the upstream pressure.	Models <b>7300</b>
	<b>Pressure Reducer Fittings</b>	Reduce the pressure consumed in one section of the machine in order to save energy.	Models <b>7316 - 7318 - 7416 - 7471</b>
	<b>Quick Exhaust Valves</b>	Increase the return speed of the cylinder by discharging the exhaust directly to atmosphere.	Models <b>7899 - 7970 - 7971</b>
	<b>Silencers</b>	Reduce the noise levels whilst air is vented from a compressed air system.	Models <b>0670 - 0671 - 0672 - 0673 0674 - 0675 - 0676 - 0677</b>
<b>Working on Your System</b>	<b>Snap Fittings</b>	Allow a circuit to be isolated without fully venting the system.	Models <b>7921 - 7926 - 7960 - 7961</b>
	<b>Manually-Operated Valves</b>	Allow for repeated venting by simply moving the valve sleeve or the manually-operated valve lever.	Models <b>0669 - 7800 - 7801 - 7802</b>

# Symbols for Function Fittings

<p><b>Regulating</b> air flow</p> 	<p><b>Regulating</b> pressure by stabilising at a required value</p> 
<p><b>Blocking</b> air circulation</p> 	<p><b>Reducing</b> pressure supply</p> 
<p><b>Blocking</b> and <b>regulating</b> air flow</p> 	<p><b>Progressive</b> pressurising of circuits</p> 
<p><b>Controlling</b> allows the passage of fluid in one direction and prevents it in the other</p> 	<p><b>Isolating a circuit</b> without venting the entire system</p> 
<p><b>Exhausting system</b> and <b>controlling</b> pneumatic circuit supply</p> 	<p><b>Regulating, blocking and venting</b> to protect the system and individuals</p> 
<p><b>Detecting</b> pressure drop</p> 	

# Selecting Your Flow Control Regulator

The comprehensive range of Parker Legris flow control regulators provides a solution for all flow regulation functions in a pneumatic system.

Select the model suited to your application according to:

## 5 Key Requirements

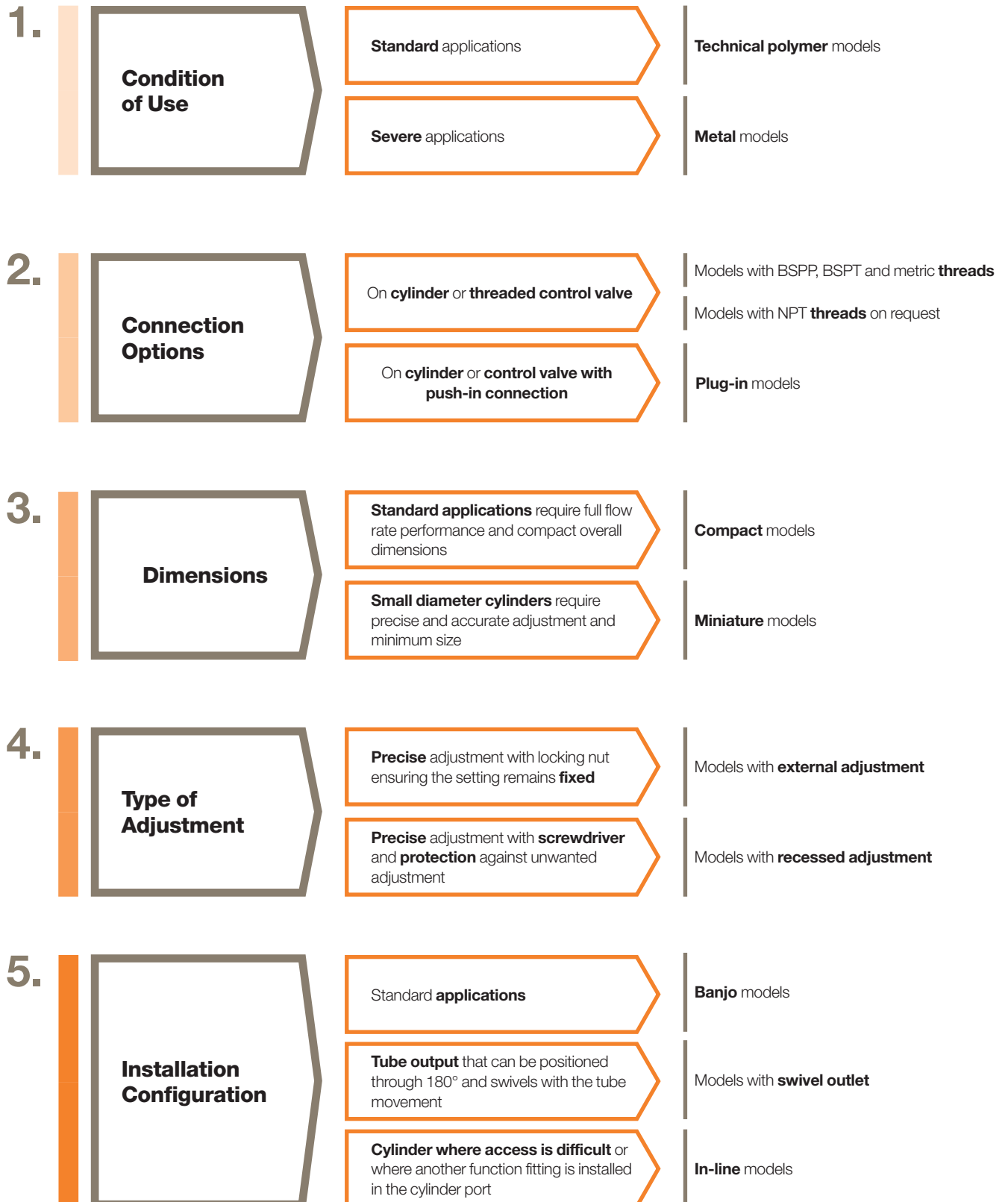

# Flow Control Regulator Range

## Technical Polymer Version, BSPP and Metric

### Recessed Adjustment

**7010**  
**7011**  
**7012**  
Push-In  
Page 4-10



### External Adjustment

**7060**  
**7061**  
**7062**  
Compact  
Push-In  
Page 4-11/12



**7660**  
**7662**  
**7669**  
Miniature  
Push-In  
Page 4-13/14



### Swivel Outlet

**7040**  
**7041**  
Compact  
Push-In  
Page 4-14



**7640**  
**7649**  
Miniature  
Push-In  
Page 4-15



### In-Line

**7770**  
**7772**  
Push-In  
Page 4-16



**7776**  
Bulkhead  
Push-In  
Page 4-16



**7771**  
Threaded  
Page 4-16



**7020**  
Straight  
Push-In  
Page 4-17



**7000**  
Page 4-16



### Plug-In

**7030**  
**7031**  
Compact  
Push-In  
Page 4-18



**7630**  
**7631**  
Miniature  
Push-In  
Page 4-18



## Technical Polymer Version, BSPT

### External Adjustment

**7065**  
**7066**  
**7067**  
Compact  
Push-In  
Page 4-11/12



**7665**  
**7668**  
Miniature  
Push-In  
Page 4-13



### Swivel Outlet and External Adjustment

**7045**  
Compact  
Push-In  
Page 4-14



**7645**  
Miniature  
Push-In  
Page 4-15



## Brass, Nickel-Plated Brass and Aluminium Versions, BSPP and Metric

### Recessed Adjustment

**7130**  
Push-In  
Page 4-19



**7140**  
Threaded  
Page 4-19



**7160**  
Compression  
Page 4-19



### In-Line

**7170**  
Bulkhead  
Threaded  
Page 4-21



### External Adjustment

**7762**  
Threaded  
Page 4-21



**7100**  
**7101**  
Compact  
Push-In  
Page 4-20



**7680**  
Compact  
Push-In  
Page 4-20



**7180**  
Miniature  
Push-In  
Page 4-20



**7110**  
**7111**  
Compact  
Threaded  
Page 4-20/21



**7190**  
Miniature  
Threaded  
Page 4-21



## Stainless Steel Versions

**7810**  
**7812**  
Threaded  
Page 4-23



**7820**  
**7822**  
Threaded  
Page 4-23



# Flow Control Regulators

Parker Legris flow control regulators with polymer, nickel-plated brass or aluminium bodies, external or recessed adjustment screws, offer **precise adjustment, accuracy** and **compactness** providing the solution for all applications.

## Product Advantages

### Improved Productivity

- Higher maximum flow than standard regulators
- Full flow with minimum pressure drop (model 7060)
- Optimal control of the cylinder rod speed
- 100% leak-tested in production
- Date coding to guarantee quality and traceability
- Reduce compressed air and energy consumption

### Accuracy & Performance

- Precise adjustment for accurate flow regulation from initial to maximum opening
- Constant cylinder rod displacement speed
- Long-term stability of flow
- Reduced weight (polymer version)
- Mechanical strength and corrosion resistance with nickel-plated brass version

### Ergonomics & Large Range

- External adjustment screw: easy to adjust without tooling and lockable
- Recessed adjustment screw: more compact and protects the adjustment mechanism
- Uni-directional: exhaust or inlet
- Bi-directional: adjustment of air flow in both directions
- 360° positioning
- NPT version on request



**Applications**

- Pneumatics
- Robotics
- Semi-Conductors
- Textile
- Automotive Process
- Packaging

## Technical Characteristics

<b>Compatible Fluids</b>	Compressed air Other fluids: contact us
<b>Working Pressure</b>	1 to 10 bar
<b>Working Temperature</b>	0°C to +70°C

<b>Max. Tightening Torques (external adjustment screw)</b>	Threads	M3 x0.5	M5 x0.8	G1/8	G1/4	G3/8	G1/2
	daN.m	0.06	0.16	0.8	1.2	3	3.5
<b>Max. Tightening Torques (recessed adjustment screw)</b>	Threads	–	M5 x0.8	G1/8	G1/4	G3/8	G1/2
	daN.m	–	0.1	0.4	0.5	0.6	0.7

You will find all the flow rate characteristic curves (to 6 bar) for flow control regulators at the end of the chapter.

### Component Materials

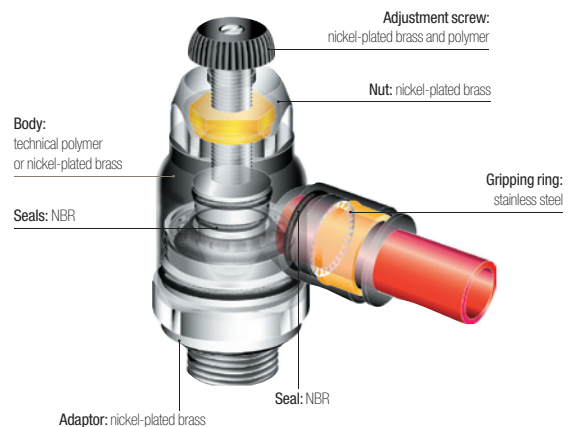

**Silicone-free**

# Flow Control Regulators

## Operation

Parker Legris offers both uni-directional and bi-directional flow control regulators.

The uni-directional models control the flow of air in one direction through an adjustable restrictor, while allowing full flow in the opposite direction.

The bi-directional models control the flow of air in both directions.

A more precise and constant flow regulation is obtained when the regulator is fitted directly onto the cylinder.

### Models with Recessed Adjustment

#### Uni-Directional (Exhaust Version)

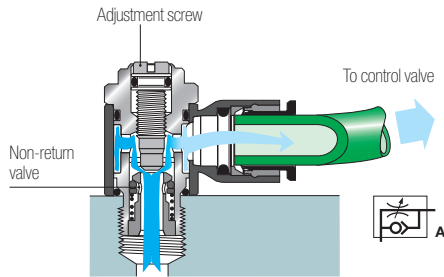

#### Uni-Directional (Supply Version)

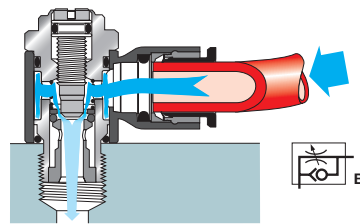

#### Bi-Directional Version

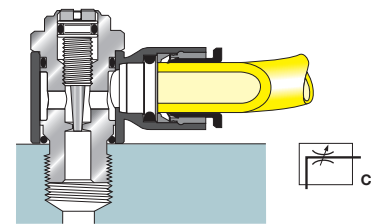

### Models with External Adjustment

#### Uni-Directional (Exhaust Version)

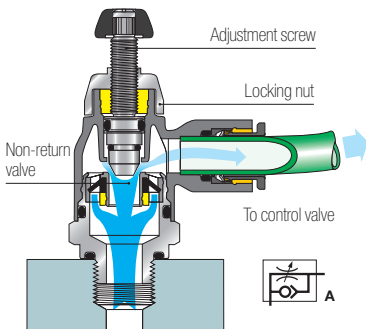

#### Uni-Directional (Supply Version)

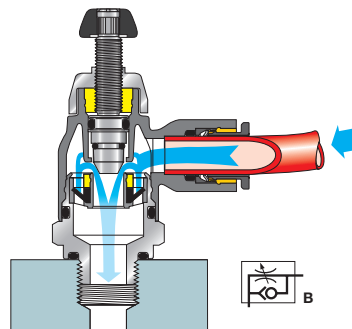

#### Bi-Directional Version

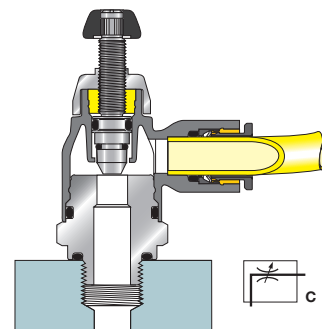

### In-Line Models

#### Uni-Directional Version

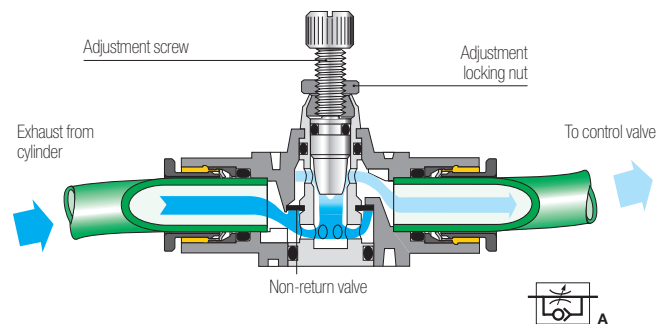

#### Bi-Directional Version

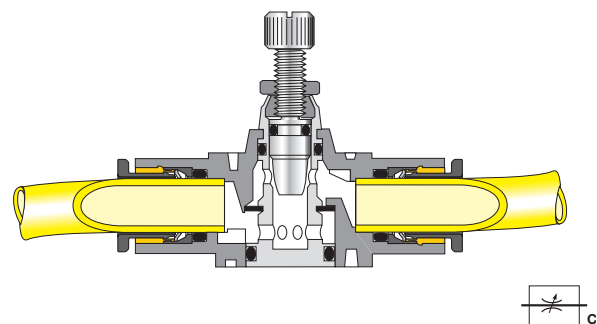

For instant visual identification, each Parker Legris flow control regulator version is identified by the related pneumatic symbol and by a letter:

- uni-directional regulation on exhaust: letter A
- uni-directional regulation on supply: letter B
- bi-directional regulation: letter C

# Regulators with Recessed Adjustment

## 7010 Flow Regulator with Recessed Adjustment Screw Exhaust, Male BSPP and Metric Thread



Technical polymer, nickel-plated brass, NBR

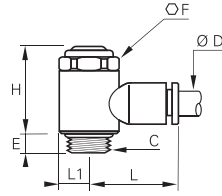

ØD	C		E	F	H	L	L1	kg
4	M5x0.8	<a href="#">7010 04 19</a>	4	8	17.5	17	5	0.006
	G1/8	<a href="#">7010 04 10</a>	5	13	25	19	7	0.018
6	M5x0.8	<a href="#">7010 06 19</a>	4	8	17.5	19	5	0.006
	G1/8	<a href="#">7010 06 10</a>	5	13	25	21	7	0.018
8	G1/4	<a href="#">7010 08 13</a>	8	17	26.5	22	9.5	0.034
	G1/8	<a href="#">7010 08 10</a>	5	13	25	26	7	0.019
10	G1/4	<a href="#">7010 10 13</a>	8	17	26.5	29	9.5	0.035
	G3/8	<a href="#">7010 10 17</a>	7.5	20	37.5	29	11	0.068
12	G1/4	<a href="#">7010 12 13</a>	8	17	26.5	29	9.5	0.035
	G3/8	<a href="#">7010 12 17</a>	7.5	20	37.5	31	11	0.067
	G1/2	<a href="#">7010 12 21</a>	8	23	43	37	13.5	0.118
	G3/8	<a href="#">7010 12 17</a>	7.5	20	37.5	34.5	11	0.069
	G1/2	<a href="#">7010 12 21</a>	8	23	43	37	13.5	0.108

## 7011 Flow Regulator with Recessed Adjustment Screw Supply, Male BSPP and Metric Thread



Technical polymer, nickel-plated brass, NBR

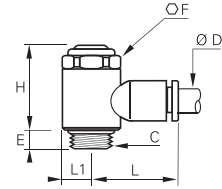

ØD	C		E	F	H	L	L1	kg
4	M5x0.8	<a href="#">7011 04 19</a>	4	8	17.5	17	5	0.006
	G1/8	<a href="#">7011 04 10</a>	5	13	25	19	7	0.018
6	M5x0.8	<a href="#">7011 06 19</a>	4	8	17.5	19	5	0.006
	G1/8	<a href="#">7011 06 10</a>	5	13	25	21	7	0.018
8	G1/4	<a href="#">7011 08 13</a>	8	17	26.5	22	9.5	0.034
	G1/8	<a href="#">7011 08 10</a>	5	13	25	26	7	0.019
10	G1/4	<a href="#">7011 10 13</a>	8	17	26.5	29	9.5	0.036
	G3/8	<a href="#">7011 10 17</a>	7.5	20	37.5	29	11	0.067
	G1/4	<a href="#">7011 10 13</a>	8	17	26.5	29	9.5	0.036
	G3/8	<a href="#">7011 10 17</a>	7.5	20	37.5	31	11	0.068

## 7012 Bi-Directional Flow Regulator with Recessed Adjustment Screw, Male BSPP and Metric Thread



Technical polymer, nickel-plated brass, NBR

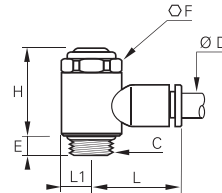

ØD	C		E	F	H	L	L1	kg
4	M5x0.8	<a href="#">7012 04 19</a>	4	8	17.5	17	5	0.006
	G1/8	<a href="#">7012 04 10</a>	5	13	25	19	7	0.018
6	M5x0.8	<a href="#">7012 06 19</a>	4	8	17.5	19	5	0.007
	G1/8	<a href="#">7012 06 10</a>	5	13	25	21	7	0.019
8	G1/4	<a href="#">7012 08 13</a>	8	17	26.5	22	9.5	0.036
	G1/8	<a href="#">7012 08 10</a>	5	13	25	26	7	0.020
10	G1/4	<a href="#">7012 10 13</a>	8	17	26.5	27	9.5	0.036
	G3/8	<a href="#">7012 10 17</a>	7.5	20	37.5	29	11	0.070

Each pneumatic function fitting is identified by:

- the item type
- the tube outside diameter
- the thread or 2<sup>nd</sup> tube outside diameter

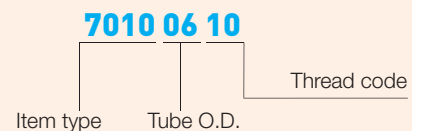

# Compact Regulators with External Adjustment

## 7060 Compact Flow Regulator Exhaust, Male BSPP Thread



Technical polymer, nickel-plated brass, NBR

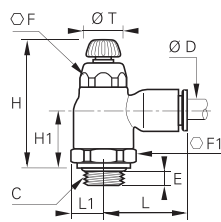

ØD	C		E	F	F1	H	H <sub>max</sub>	H1	L	L1	ØT	kg
4	G1/8	<a href="#">7060 04 10</a>	5	10	16	38	44	16	22	9	10	0.020
	G1/8	<a href="#">7060 06 10</a>	5	10	16	38	44	16	22	9	10	0.020
6	G1/4	<a href="#">7060 06 13</a>	5.5	10	16	36.5	42.5	15	22	9	10	0.020
	G1/8	<a href="#">7060 08 10</a>	4.5	14	19	41.5	48	18	28	10.5	14	0.033
8	G1/4	<a href="#">7060 08 13</a>	5.5	14	19	41.5	48	18.5	28	10.5	14	0.034
	G3/8	<a href="#">7060 08 17</a>	5.5	14	19	41.5	48	17	28	11	14	0.034
10	G1/4	<a href="#">7060 10 13</a>	5.5	17	23	45.5	53.5	20	31.5	12.5	17	0.053
	G3/8	<a href="#">7060 10 17</a>	5.5	17	23	45.5	54	20	31.5	12.5	17	0.054
12	G3/8	<a href="#">7060 12 17</a>	5.5	17	23	45.5	54	20	35	12.5	17	0.060
	G1/2	<a href="#">7060 12 21</a>	7.5	17	24	45.5	54	20	35	13	17	0.058

## 7065 Compact Flow Regulator Exhaust, Male BSPT Thread



Technical polymer, nickel-plated brass, NBR

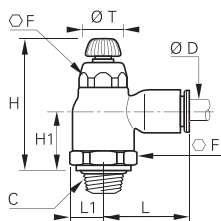

ØD	C		F	F1	H <sub>min</sub>	H <sub>max</sub>	H1	L	L1	ØT	kg
6	R1/8	<a href="#">7065 06 10</a>	10	16	36.5	42.5	15	22	8	10	0.021
8	R1/8	<a href="#">7065 08 10</a>	14	19	40	45	16.5	28	10.5	14	0.034
	R1/4	<a href="#">7065 08 13</a>	14	19	40	45	16.5	28	10.5	14	0.036
10	R1/4	<a href="#">7065 10 13</a>	17	23	43.5	51.5	18	31.5	12.5	17	0.053
	R3/8	<a href="#">7065 10 17</a>	17	23	43.5	51.5	18	31.5	12.5	17	0.055
12	R1/2	<a href="#">7065 10 21</a>	17	23	43.5	51.5	18	31.5	12.5	17	0.059
	R1/4	<a href="#">7065 12 13</a>	17	23	43.5	51.5	18	35	12.5	17	0.056
12	R3/8	<a href="#">7065 12 17</a>	17	23	43.5	51.5	18	35	12.5	17	0.059
	R1/2	<a href="#">7065 12 21</a>	17	23	43.5	51.5	18	35	12.5	17	0.064

Pre-coated thread

## 7061 Compact Flow Regulator Supply, Male BSPP Thread



Technical polymer, nickel-plated brass, NBR

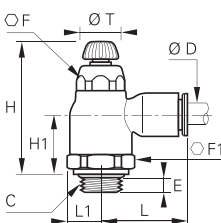

ØD	C		E	F	F1	H	H <sub>max</sub>	H1	L	L1	ØT	kg
4	G1/8	<a href="#">7061 04 10</a>	5	10	16	38	44	16	22	9	10	0.020
	G1/8	<a href="#">7061 06 10</a>	5	10	16	38	44	16	22	9	10	0.020
6	G1/4	<a href="#">7061 06 13</a>	5.5	10	16	36.5	42.5	15	22	9	10	0.021
	G1/8	<a href="#">7061 08 10</a>	4.5	14	19	41.5	48	18	28	10.5	14	0.033
8	G1/4	<a href="#">7061 08 13</a>	5.5	14	19	41.5	48	18.5	28	10.5	14	0.034
	G3/8	<a href="#">7061 08 17</a>	5.5	14	23	41.5	48	17	28	11	14	0.033
10	G1/4	<a href="#">7061 10 13</a>	5.5	17	23	45.5	53.5	20	31.5	12.5	17	0.053
	G3/8	<a href="#">7061 10 17</a>	5.5	17	23	45.5	54	20	31.5	12.5	17	0.054
12	G1/2	<a href="#">7061 12 21</a>	7.5	17	24	45.5	54	20	35	13	17	0.060

## 7066 Compact Flow Regulator Supply, Male BSPT Thread



Technical polymer, nickel-plated brass, NBR

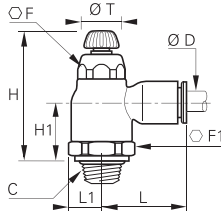

ØD	C		F	F1	H <sub>min</sub>	H <sub>max</sub>	H1	L	L1	ØT	kg
10	R1/4	<a href="#">7066 10 13</a>	17	23	43.5	51.5	18	31.5	12.5	17	0.020
	R3/8	<a href="#">7066 10 17</a>	17	23	43.5	51.5	18	31.5	12.5	17	0.020
	R1/2	<a href="#">7066 10 21</a>	17	23	43.5	51.5	18	31.5	12.5	17	0.059
12	R1/4	<a href="#">7066 12 13</a>	17	23	43.5	51.5	18	35	12.5	17	0.056
	R3/8	<a href="#">7066 12 17</a>	17	23	43.5	51.5	18	35	12.5	17	0.059
	R1/2	<a href="#">7066 12 21</a>	17	23	43.5	51.5	18	35	12.5	17	0.064

Pre-coated thread

# Compact Regulators with External Adjustment

## 7062 Bi-Directional Compact Flow Regulator, Male BSPP Thread



Technical polymer, nickel-plated brass, NBR

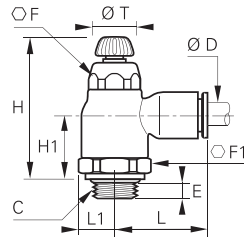

ØD	C		E	F	F1	H	H <sub>max</sub>	H1	L	L1	ØT	kg
4	G1/8	<a href="#">7062 04 10</a>	5	10	16	38	44	16	22	9	10	0.025
6	G1/8	<a href="#">7062 06 10</a>	5	10	16	38	44	16	22	9	10	0.025
	G1/4	<a href="#">7062 06 13</a>	5.5	10	16	36.5	42.5	15	22	9	10	0.025
8	G1/8	<a href="#">7062 08 10</a>	4.5	14	19	41.5	48	18	28	10.5	14	0.043
	G3/8	<a href="#">7062 08 17</a>	5.5	14	19	41.5	48	17	28	11	14	0.042

## 7067 Bi-Directional Compact Flow Regulator, Male BSPT Thread



Technical polymer, nickel-plated brass, NBR

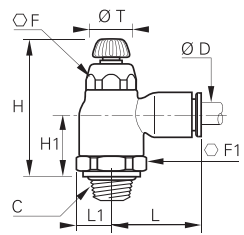

ØD	C		F	F1	H <sub>min</sub>	H <sub>max</sub>	H1	L	L1	ØT	kg
4	R1/8	<a href="#">7067 04 10</a>	10	16	36.5	42.5	14.7	22	9	10	0.025
6	R1/8	<a href="#">7067 06 10</a>	10	16	36.5	42.5	14.7	22	9	10	0.010
	R1/4	<a href="#">7067 06 13</a>	10	16	36.5	42.5	14.7	22	9	10	0.014
8	R1/8	<a href="#">7067 08 10</a>	14	19	40	45	16.5	28	10.5	14	0.034
	R1/4	<a href="#">7067 08 13</a>	14	19	40	45	16.5	28	10.5	14	0.036
	R3/8	<a href="#">7067 08 17</a>	14	19	40	45	16.5	28	11	14	0.042

Pre-coated thread

# Miniature Regulators with External Adjustment

**7660**

Miniature Flow Regulator Exhaust, Male BSPP and Metric Thread



Technical polymer, nickel-plated brass, NBR

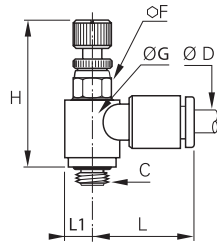

ØD	C		F	G	H min	H max	L	L1	kg
3	M3x0.5	<a href="#">7660 03 09</a>	6	9	23.5	26	17	4.5	0.007
	M5x0.8	<a href="#">7660 03 19</a>	6	9	23.5	26	17	4.5	0.006
4	M3x0.5	<a href="#">7660 04 09</a>	6	9	23.5	26	16.5	4.5	0.007
	M5x0.8	<a href="#">7660 04 19</a>	6	9	23.5	26	17	4.5	0.006
6	G1/8	<a href="#">7660 06 10</a>	7	11.5	27	29.5	18	6	0.012
	M5x0.8	<a href="#">7660 06 19</a>	6	9	23.5	26	18	4.5	0.007
8	G1/4	<a href="#">7660 08 13</a>	8	12	30	32.5	19	6	0.019
	G1/8	<a href="#">7660 08 10</a>	13	14	26.5	31	26	7	0.021
	G3/8	<a href="#">7660 08 17</a>	20	23	36	42	29	11.5	0.062

**7665**

Miniature Flow Regulator Exhaust, Male BSPT Thread



Technical polymer, nickel-plated brass, NBR

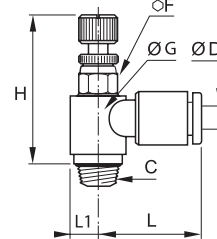

ØD	C		F	G	H min	H max	L	L1	kg
4	R1/8	<a href="#">7665 04 10</a>	7	11.5	25	27.5	18	6	0.012
	R1/8	<a href="#">7665 06 10</a>	7	11.5	25	27.5	18.5	6	0.012
6	R1/4	<a href="#">7665 06 13</a>	8	13.5	27.5	30	19	7	0.019
	R3/8	<a href="#">7665 06 17</a>	17	13.5	31.5	34	19	7	0.025
8	R1/8	<a href="#">7665 08 10</a>	13	14	24	28.5	26	7	0.021
	R3/8	<a href="#">7665 08 17</a>	16	19	25	29	27.5	9.5	0.033

Pre-coated thread

**7669**

Miniature Flow Regulator Supply, Male BSPP and Metric Thread



Technical polymer, nickel-plated brass, NBR

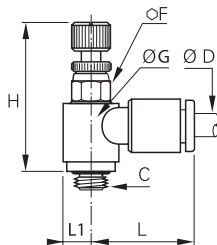

ØD	C		F	G	H min	H max	L	L1	kg
3	M3x0.5	<a href="#">7669 03 09</a>	6	9	23.5	26	17	4.5	0.008
	M5x0.8	<a href="#">7669 03 19</a>	6	9	23.5	26	17	4.5	0.007
4	M5x0.8	<a href="#">7669 04 19</a>	6	9	23.5	26	17	4.5	0.006
	G1/8	<a href="#">7669 04 10</a>	7	11.5	27	29.5	18	6	0.012
6	M5x0.8	<a href="#">7669 06 19</a>	6	9	23.5	26	18	4.5	0.007
	G1/8	<a href="#">7669 06 10</a>	7	11.5	27	29.5	18.5	6	0.013
	G1/4	<a href="#">7669 06 13</a>	8	12	30	32.5	19	6	0.019
8	G1/8	<a href="#">7669 08 10</a>	13	14	26.5	31	26	7	0.021
	G1/4	<a href="#">7669 08 13</a>	16	19	29	34	27.5	9.5	0.033
	G3/8	<a href="#">7669 08 17</a>	20	23	36	42	29	11.5	0.063

**7668**

Miniature Flow Regulator Supply, Male BSPT Thread



Technical polymer, nickel-plated brass, NBR

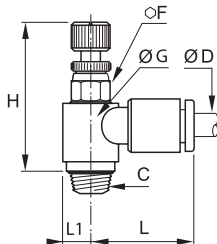

ØD	C		F	G	H min	H max	L	L1	kg
4	R1/8	<a href="#">7668 04 10</a>	7	11.5	25	27.5	18	6	0.011
	R1/8	<a href="#">7668 06 10</a>	7	11.5	25	27.5	18.5	6	0.012
6	R1/4	<a href="#">7668 06 13</a>	8	13.5	27.5	30	19	7	0.019
	R1/8	<a href="#">7668 08 10</a>	13	14	24	28.5	26	7	0.020
8	R1/4	<a href="#">7668 08 13</a>	16	19	25	29	27.5	9.5	0.032
	R3/8	<a href="#">7668 08 17</a>	20	23	30	36	29	11.5	0.061

Pre-coated thread

# Regulators with External Adjustment

**7662**

Bi-Directional Miniature Flow Regulator, Male BSPP and Metric Thread



Technical polymer, nickel-plated brass, NBR

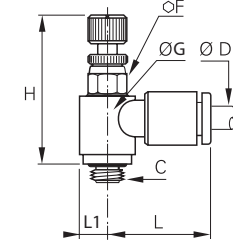

ØD	C		F	G	H <sub>min</sub>	H <sub>max</sub>	L	L1	kg
4	M5x0.8	<a href="#">7662 04 19</a>	6	9	23.5	26	17	4.5	0.007
	G1/8	<a href="#">7662 04 10</a>	7	11.5	27	29.5	18	6	0.013
6	M5x0.8	<a href="#">7662 06 19</a>	6	9	23.5	26	18	4.5	0.010
	G1/8	<a href="#">7662 06 10</a>	7	11.5	27	29.5	18.5	6	0.013
	G1/4	<a href="#">7662 06 13</a>	8	12	30	32.5	19	6	0.019

**7040**

Compact Flow Regulator Swivel Outlet Exhaust, Male BSPP Thread



Technical polymer, nickel-plated brass, NBR

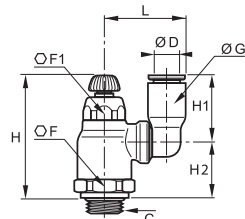

ØD	C		F	F1	G	H <sub>min</sub>	H <sub>max</sub>	H1	H2	L	kg
6	G1/8	<a href="#">7040 06 10</a>	16	10	10.5	38	44	16	18	23.5	0.024
	G1/4	<a href="#">7040 06 13</a>	16	10	10.5	36.5	42.5	16	16.5	23.5	0.025
8	G1/8	<a href="#">7040 08 10</a>	19	14	13.5	41.5	48	23	19	28	0.037
	G1/4	<a href="#">7040 08 13</a>	19	14	13.5	41.5	48	23	19.5	28	0.039
10	G3/8	<a href="#">7040 08 17</a>	19	14	13.5	41.5	48	23	17.5	28	0.020
	G1/4	<a href="#">7040 10 13</a>	23	17	16	45.5	53.5	26.5	21	35	0.051
12	G3/8	<a href="#">7040 10 17</a>	23	17	16	45.5	54	26.5	21.5	35	0.063
	G1/2	<a href="#">7040 12 21</a>	23	17	19	45.5	54	30.5	21.5	38	0.066
	G1/2	<a href="#">7040 12 21</a>	24	17	19	45.5	54	30.5	21	38	0.071

**7045**

Compact Flow Regulator Swivel Outlet Exhaust, Male BSPT Thread



Technical polymer, nickel-plated brass, NBR

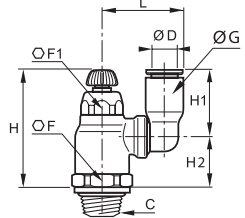

ØD	C		F	F1	G	H <sub>min</sub>	H <sub>max</sub>	H1	H2	L	kg
6	R1/4	<a href="#">7045 06 13</a>	16	10	10.5	36.5	42.5	16	16.5	23.5	0.030
	R1/8	<a href="#">7045 08 10</a>	19	14	13.5	40	46	23	17	28	0.014
8	R1/4	<a href="#">7045 08 13</a>	19	14	13.5	40	46	23	17	28	0.043
	R3/8	<a href="#">7045 08 17</a>	19	14	13.5	40	46	23	17	28	0.044
10	R1/4	<a href="#">7045 10 13</a>	23	17	16	43.5	51.5	26.5	19	35	0.062
	R3/8	<a href="#">7045 10 17</a>	23	17	16	43.5	51.5	26.5	19	35	0.065
12	R3/8	<a href="#">7045 12 17</a>	23	17	19	43.5	51.5	31	19	38	0.065
	R1/2	<a href="#">7045 12 21</a>	23	17	19	43.5	51.5	31	19	38	0.070

Pre-coated thread

**7041**

Compact Flow Regulator Swivel Outlet Supply, Male BSPP Thread



Technical polymer, nickel-plated brass, NBR

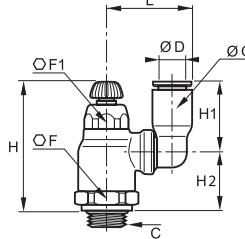

ØD	C		F	F1	G	H <sub>min</sub>	H <sub>max</sub>	H1	H2	L	kg
6	G1/4	<a href="#">7041 06 13</a>	16	10	10.5	36.5	42.5	16	16.5	23.5	0.024
8	G1/8	<a href="#">7041 08 10</a>	19	14	13.5	41.5	48	23	19	28	0.037
	G1/4	<a href="#">7041 08 13</a>	19	14	13.5	41.5	48	23	19.5	28	0.039

# Miniature Regulators with Swivel Outlet and External Adjustment

**7640**

Miniature Swivel Outlet Flow Regulator Exhaust, Male BSPP and Metric Thread



Technical polymer, nickel-plated brass, NBR

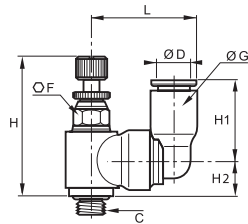

ØD	C		F	G	H <sub>min</sub>	H <sub>max</sub>	H1	H2	L	kg
4	M5x0.8	<a href="#">7640 04 19</a>	6	8.5	23.5	26	14	6.5	19.5	0.011
	G1/8	<a href="#">7640 04 10</a>	7	8.5	27	29.5	14	8	19.5	0.015
6	M5x0.8	<a href="#">7640 06 19</a>	6	10.5	23.5	26	16	6.5	21	0.001
	G1/8	<a href="#">7640 06 10</a>	7	10.5	27	29.5	16	8	20.5	0.015

**7645**

Miniature Swivel Outlet Flow Regulator Exhaust, Male BSPT Thread



Technical polymer, nickel-plated brass, NBR

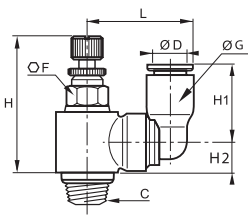

ØD	C		F	G	H <sub>min</sub>	H <sub>max</sub>	H1	H2	J	L	kg
4	R1/8	<a href="#">7645 04 10</a>	7	8.5	25	27.5	14	6	11.5	19.5	0.014
6	R1/8	<a href="#">7645 06 10</a>	7	10.5	25	27.5	16	6	11.5	21.5	0.012

Pre-coated thread

**7649**

Miniature Swivel Outlet Flow Regulator Supply, Male BSPP and Metric Thread



Technical polymer, nickel-plated brass, NBR

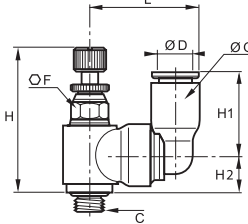

ØD	C		F	G	H <sub>min</sub>	H <sub>max</sub>	H1	H2	L	kg
4	M5x0.8	<a href="#">7649 04 19</a>	6	8.5	23.5	26	14	6.5	19	0.015
	G1/8	<a href="#">7649 04 10</a>	7	8.5	27	29.5	14	8.5	19.5	0.014
6	M5x0.8	<a href="#">7649 06 19</a>	6	10.5	23.5	26	16	6.5	21	0.008
	G1/8	<a href="#">7649 06 10</a>	7	10.5	27	29.5	16	8.5	21.5	0.015

## Associated Products

All our flow control regulators are compatible with the range of polyamide and polyurethane tubing shown in Chapter 3.

# In-Line Regulators with External Adjustment

## 7770 In-Line One-Way Flow Regulator



Technical polymer, NBR

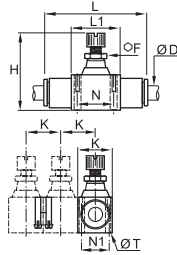

ØD		F	H <sub>min</sub>	H <sub>max</sub>	K	L	L1	N	N1	ØT	kg
4	<a href="#">7770 04 00</a>	5	29.5	33.5	12	36	15	11	8	2.2	0.010
6	<a href="#">7770 06 00</a>	8	40.5	44.5	17	51	23	17	11	3.2	0.028
8	<a href="#">7770 08 00</a>	11	46.5	52.5	18.5	58	26	20	12.5	3.2	0.048
10	<a href="#">7770 10 00</a>	14	53	61	24	73	33	26	16	4.2	0.097
12	<a href="#">7770 12 00</a>	14	59	67.5	28	85	35	27.5	20	4.2	0.132

## 7772 Bi-Directional In-Line Flow Regulator



Technical polymer, NBR

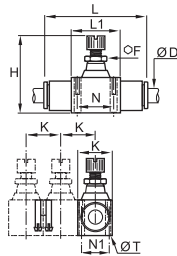

ØD		F	H <sub>min</sub>	H <sub>max</sub>	K	L	L1	N	N1	ØT	kg
4	<a href="#">7772 04 00</a>	5	29.5	33.5	12	36	15	11	8	2.2	0.011
6	<a href="#">7772 06 00</a>	8	40	44.5	17	51	23	17	11	3.2	0.032
8	<a href="#">7772 08 00</a>	11	46.5	52.5	18.5	58	26	20	12.5	3.2	0.054

## 7776 Panel-Mountable In-Line One-Way Flow Regulator

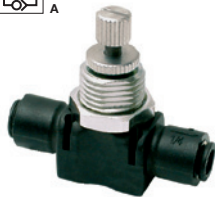

Technical polymer, NBR

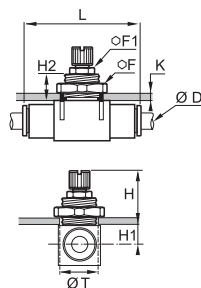

ØD		F	F1	H	H <sub>max</sub>	H1	H2	K	L	ØT	kg
4	<a href="#">7776 04 00*</a>	14	-	21.5	25.5	6.5	11	6	36	10.5	0.017
6	<a href="#">7776 06 00*</a>	19	-	27.5	32.5	7.5	13.5	7	51	16.5	0.042
8	<a href="#">7776 08 00</a>	24	11	28.5	34.5	9	13.5	7	58	18.5	0.069
10	<a href="#">7776 10 00</a>	30	14	29.5	38.5	11.5	13.5	7	73	24.5	0.136
12	<a href="#">7776 12 00</a>	32	14	32	42	12.5	15.5	8	85	27.5	0.185

\*Ultrafine adjustment

## 7771 In-Line One-Way Flow Regulator, Female BSPP Thread



Technical polymer, nickel-plated brass, NBR

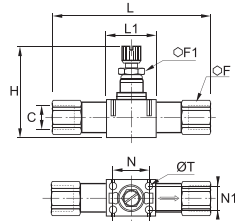

C		F	F1	H <sub>min</sub>	H <sub>max</sub>	L	L1	N	N1	ØT	kg
G1/8	<a href="#">7771 10 10</a>	13	8	39.5	44.5	68.5	23	17	11	3.2	0.043
G1/4	<a href="#">7771 13 13</a>	16	11	44	50	83	26	20	12.5	3.2	0.103
G3/8	<a href="#">7771 17 17</a>	19	14	52	61	97	33	26	16	4.2	0.160
G1/2	<a href="#">7771 21 21</a>	24	14	57.5	67.5	121	35	27.5	20	4.2	0.260

## 7000 Joining Clips



Technical polymer



ØD		kg
4	<a href="#">7000 00 05</a>	0,004
6	<a href="#">7000 00 05</a>	0,004
8	<a href="#">7000 00 05</a>	0,004
10	<a href="#">7000 00 06</a>	0,009
12	<a href="#">7000 00 06</a>	0,009

# In-Line Regulators with External Adjustment

**7020**

Straight Flow Regulator Exhaust, Male BSPP Thread



Technical polymer, nickel-plated brass, NBR

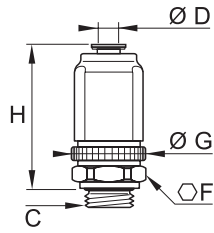

ØD	C		F	G	H min	H max	kg
4	G1/8	<a href="#">7020 04 10</a>	18	21.5	38.5	44	0.062
6	G1/8	<a href="#">7020 06 10</a>	18	21.5	38.5	44	0.058
	G1/4	<a href="#">7020 06 13</a>	18	21.5	38.5	44	0.059
8	G1/8	<a href="#">7020 08 10</a>	24	27	46.5	52.5	0.110
	G1/4	<a href="#">7020 08 13</a>	24	27	46.5	52.5	0.112

# Plug-In Regulators with External Adjustment

## 7030

### Compact Plug-In Flow Regulator, Exhaust



Technical polymer, nickel-plated brass, NBR

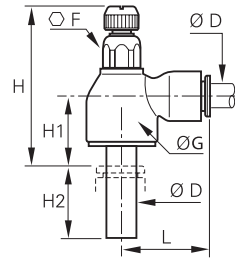

ØD		F	G	H min	H max	H1	H2	L	kg
6	<a href="#">7030 06 00</a>	10	16	35	41	14	17	22	0.013
8	<a href="#">7030 08 00</a>	14	19	39.5	46.5	16	21.5	28	0.022
10	<a href="#">7030 10 00</a>	17	23	43.5	51.5	17.5	24.5	31.5	0.030
12	<a href="#">7030 12 00</a>	17	23	43	51	17	27	35	0.044

## 7031

### Compact Plug-In Flow Regulator, Supply



Technical polymer, nickel-plated brass, NBR

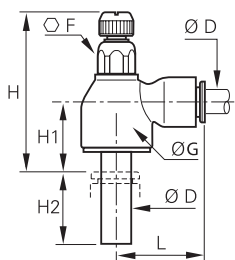

ØD		F	G	H min	H max	H1	H2	L	kg
6	<a href="#">7031 06 00</a>	10	16	35	41	14	17	22	0.013
8	<a href="#">7031 08 00</a>	14	19	39.5	46.5	16	21.5	28	0.035
10	<a href="#">7031 10 00</a>	17	23	43.5	51.5	17.5	24.5	31.5	0.010
12	<a href="#">7031 12 00</a>	17	23	43	51	17	27	35	0.044

## 7630

### Miniature Plug-In Flow Regulator, Exhaust



Technical polymer, nickel-plated brass, NBR

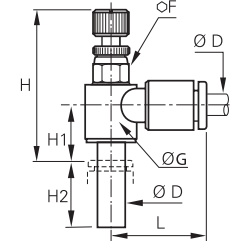

ØD		F	G	H min	H max	H1	H2	L	kg
4	<a href="#">7630 04 00</a>	6	9	25.5	28	9.5	15.5	17	0.007
6	<a href="#">7630 06 00</a>	7	11.5	27.5	29	10.5	17	18.5	0.012

## 7631

### Miniature Plug-In Flow Regulator, Supply



Technical polymer, nickel-plated brass, NBR

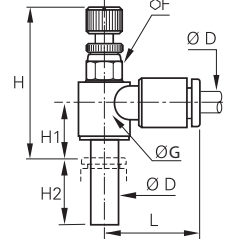

ØD		F	G	H min	H max	H1	H2	L	kg
4	<a href="#">7631 04 00</a>	6	9	25.5	28	9.5	15.5	17	0.007
6	<a href="#">7631 06 00</a>	7	11.5	27.5	29	10.5	17	18.5	0.011

# Metal Regulators with Recessed Adjustment

## 7130 Flow Regulator, Exhaust, Male BSPP and Metric Thread



Nickel-plated brass, NBR

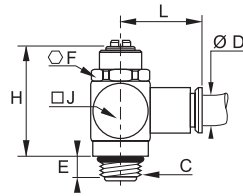

ØD	C		E	F	H	J	L	kg
4	M5x0.8	<a href="#">7130 04 19</a>	4	8	17	9	19	0.015
	G1/8	<a href="#">7130 04 10</a>	5	13	34	15	20	0.037
6	M5x0.8	<a href="#">7130 06 19</a>	4	8	17	9	24	0.013
	G1/8	<a href="#">7130 06 10</a>	5	13	34	15	22	0.038
8	G1/4	<a href="#">7130 06 13</a>	8	17	39	18	24	0.062
	G1/8	<a href="#">7130 08 10</a>	5	13	34	15	25	0.042
	G3/8	<a href="#">7130 08 17</a>	7	20	47	21.5	29	0.109
10	G1/4	<a href="#">7130 10 13</a>	8	17	39	18	30	0.075
	G3/8	<a href="#">7130 10 17</a>	7	20	47	21.5	32	0.120
12	G1/2	<a href="#">7130 10 21</a>	8	23	61	28	34	0.222
	G3/8	<a href="#">7130 12 17</a>	7	20	47	22	36	0.064
	G1/2	<a href="#">7130 12 21</a>	8	23	61	28	38	0.306

## 7140 Flow Regulator, Exhaust, Male/Female BSPP and Metric Thread



Nickel-plated brass, NBR

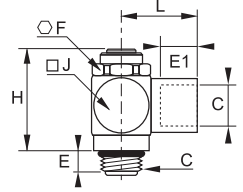

C		E	E1	F	H	J	L	kg
M5x0.8	<a href="#">7140 19 19</a>	4	4	8	21	9	11	0.009
G1/8	<a href="#">7140 10 10</a>	5	8	13	32	15	17	0.040
G1/4	<a href="#">7140 13 13</a>	8	12	17	39	18	24	0.073
G3/8	<a href="#">7140 17 17</a>	7	12	20	47	21.5	27	0.125
G1/2	<a href="#">7140 21 21</a>	8	15	23	61	28	31	0.238

## 7160 Flow Regulator with Brass Compression Fitting, Exhaust, Male BSPP Thread



Nickel-plated brass, NBR

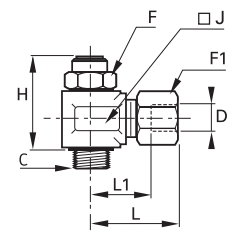

ØD	C		F	F1	H	J	L	L1	kg
4	G1/8	<a href="#">7160 04 10</a>	13	10	26	17	25.5	14.5	0.049
	G1/8	<a href="#">7160 06 10</a>	13	13	26	17	25.5	14.5	0.054
6	G1/4	<a href="#">7160 06 13</a>	17	13	31.5	22	28.5	17.5	0.103
	G1/8	<a href="#">7160 08 10</a>	13	14	26	17	29.5	15.5	0.055
8	G1/4	<a href="#">7160 08 13</a>	17	14	31.5	22	31	17	0.103
	G1/4	<a href="#">7160 10 13</a>	17	19	31.5	22	35	19	0.118
10	G3/8	<a href="#">7160 10 17</a>	20	19	44.5	22	37.5	19	0.188
	G1/2	<a href="#">7160 10 21</a>	23	19	50	27	37.5	19	0.202
12	G3/8	<a href="#">7160 12 17</a>	20	22	44.5	22	38	21.5	0.200
	G1/2	<a href="#">7160 12 21</a>	23	22	50	27	38	21.5	0.213

# Metal Regulators with External Adjustment

## 7100 Compact Flow Regulator, Exhaust, Male BSPP Thread



Nickel-plated brass, NBR

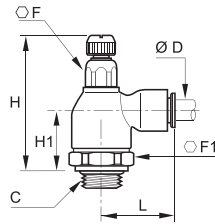

ØD	C		F	F1	H <sub>min</sub>	H <sub>max</sub>	H1	L	kg
4	G1/8	<a href="#">7100 04 10</a>	10	19	47	53	23	21	0.078
	G1/8	<a href="#">7100 06 10</a>	10	19	47	53	23	24.5	0.080
6	G1/4	<a href="#">7100 06 13</a>	10	19	47.5	53	23.5	24.5	0.083
	G1/8	<a href="#">7100 08 10</a>	14	19	50	55	24.5	29	0.097
8	G1/4	<a href="#">7100 08 13</a>	14	19	50	56	25	29	0.100
	G3/8	<a href="#">7100 08 17</a>	17	25	56	62	27	30.5	0.154
10	G1/4	<a href="#">7100 10 13</a>	14	19	50	56	25	35	0.103
	G3/8	<a href="#">7100 10 17</a>	17	25	56	62	27	35	0.157
12	G3/8	<a href="#">7100 12 17</a>	17	25	56	62	27	38	0.198
	G1/2	<a href="#">7100 12 21</a>	17	25	55	62	27	38	0.207
14	G1/2	<a href="#">7100 14 21</a>	17	25	55	62	27	41	0.205

## 7101 Compact Flow Regulator, Supply, Male BSPP Thread



Nickel-plated brass, NBR

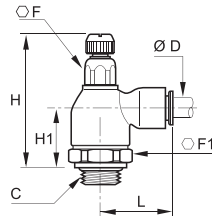

ØD	C		F	F1	H <sub>min</sub>	H <sub>max</sub>	H1	L	kg
4	G1/8	<a href="#">7101 04 10</a>	10	19	47	53	23	21	0.096
	G1/8	<a href="#">7101 06 10</a>	10	19	47	53	23	24.5	0.080
6	G1/4	<a href="#">7101 06 13</a>	10	19	47.5	53	23.5	24.5	0.080
	G1/8	<a href="#">7101 08 10</a>	14	19	50	55	24.5	29	0.097
8	G1/4	<a href="#">7101 08 13</a>	14	19	50	56	25	29	0.100
	G3/8	<a href="#">7101 08 17</a>	17	25	56	62	27	30.5	0.155

## 7680 Compact Flow Regulator, Male BSPP Thread



Nickel-plated brass, NBR

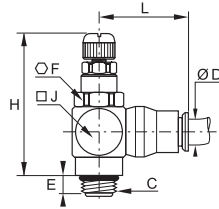

ØD	C		E	F	H <sub>min</sub>	H <sub>max</sub>	J	L	kg
6	G1/8	<a href="#">7680 06 10</a>	5	13	39	44	7.5	24.5	0.045
	G1/8	<a href="#">7680 08 10</a>	5	13	39	44	7.5	24.5	0.047
8	G1/4	<a href="#">7680 08 13</a>	8	17	41	47	9	27	0.076
	G3/8	<a href="#">7680 10 17</a>	7	20	50	60	11	34	0.133
12	G1/2	<a href="#">7680 12 21</a>	8	23	65	77	14	36.5	0.165

## 7180 Miniature Flow Regulator Exhaust, Male BSPP and Metric Thread



Nickel-plated brass, NBR

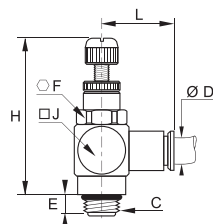

ØD	C		E	F	H <sub>min</sub>	H <sub>max</sub>	J	L	kg
4	M5x0.8	<a href="#">7180 04 19</a>	4	8	24	29	10	19	0.012
	G1/8	<a href="#">7180 04 10</a>	5	13	39	44	15	20	0.042
6	M5x0.8	<a href="#">7180 06 19</a>	4	8	24	29	10	24	0.015
	G1/8	<a href="#">7180 06 10</a>	5	13	39	44	15	22	0.043
8	G1/8	<a href="#">7180 08 10</a>	5	13	39	44	15	26	0.049

## 7110 Compact Flow Regulator Exhaust, Male/Female BSPP Thread



Nickel-plated brass, NBR

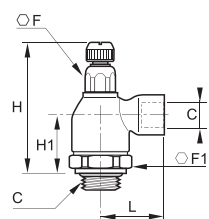

C		F	F1	H <sub>min</sub>	H <sub>max</sub>	H1	L	kg
G1/8	<a href="#">7110 10 10</a>	10	19	47	52.5	23	22.5	0.079
G1/4	<a href="#">7110 13 13</a>	14	19	50.5	55.5	25	32	0.108
G3/8	<a href="#">7110 17 17</a>	17	25	56	62	27	34.5	0.212
G1/2	<a href="#">7110 21 21</a>	17	25	55	62	27	37.5	0.192

# Metal Regulators with External Adjustment

## 7111 Compact Flow Regulator Supply, Male/Female BSPP Thread



Nickel-plated brass, NBR

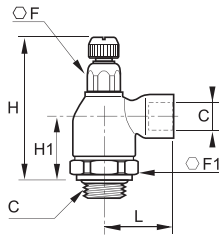

C		F	F1	H min	H max	H1	L	kg
G1/8	<a href="#">7111 10 10</a>	10	19	47	52.5	23	22.5	0.079
G1/4	<a href="#">7111 13 13</a>	14	19	50.5	55.5	25	32	0.107

## 7190 Miniature Flow Regulator Exhaust, Male/Female BSPP and Metric Thread



Nickel-plated brass, NBR

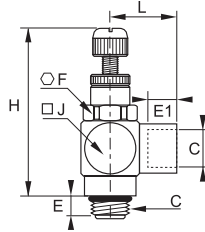

C		E	E1	F	H min	H max	J	L	kg
M5x0.8	<a href="#">7190 19 19</a>	4	4	8	24	29	10	11	0.012
G1/8	<a href="#">7190 10 10</a>	5	8	13	39	44	15	17	0.044

## 7762 Flow Regulator Exhaust, with Brass Compression Fitting, Male BSPP Thread



Brass, NBR

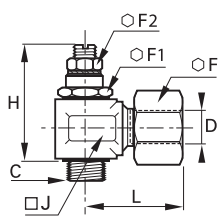

ØD	C		F	F1	F2	H min	H max	J	L	kg
8	G1/8	<a href="#">7762 08 10*</a>	14	14	7	35.5	38.5	17	28.5	0.056
10	G1/4	<a href="#">7762 10 13</a>	19	17	10	44	49	22	36.5	0.129
14	G3/8	<a href="#">7762 14 17</a>	24	22	13	58	65	27	37.5	0.219
18	G1/2	<a href="#">7762 18 21</a>	30	27	19	62.5	68.5	34	44	0.403

\*with adjustment knurl

## 7170 Panel-Mountable In-Line Flow Regulator, Female BSPP and Metric Thread



Treated aluminium, NBR

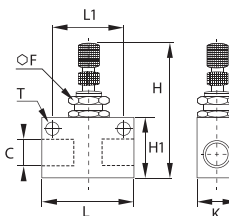

C		F	H min	H max	H1	K	L	L1	ØT	kg
M5x0.8	<a href="#">7170 19 19</a>	12	38	42	15	12	25	18	4.5	0.022
G1/8	<a href="#">7170 10 10</a>	15	49	56	22	18	35	24.7	4.5	0.056
G1/4	<a href="#">7170 13 13</a>	15	57	64	30	20	46	35	6.5	0.086
G3/8	<a href="#">7170 17 17</a>	22	62	73	30	25	50	35	6.5	0.155
G1/2	<a href="#">7170 21 21</a>	22	72	83	40	25	60	44	6.5	0.196

# Stainless Steel Flow Control Regulators

Stainless steel flow control regulators are used to **regulate the speed of a cylinder rod** as well as gas flow in environments with high mechanical or chemical constraints.

## Product Advantages

**Robust** | Suitable for corrosive environments  
 Excellent mechanical and chemical resistance  
 100% leak-tested in production  
 No contamination of conveyed fluids

**Optimised Design** | Smooth external surfaces to facilitate cleaning  
 Fully compatible with food environments  
 Accurate and easy adjustment

**Applications**  
 Food Process  
 Robotics  
 Textile  
 Semi-Conductors  
 Packaging  
 Pneumatics  
 Automotive Process

## Technical Characteristics

<b>Compatible Fluids</b>	Compressed air <b>7822:</b> all compatible fluids depending on whether FKM or PTFE seals are used
<b>Working Pressure</b>	<b>7810-7812:</b> 1 to 10 bar <b>7820:</b> 1 to 16 bar <b>7822:</b> 1 to 40 bar
<b>Working Temperature</b>	<b>7810 – 7812:</b> 0°C to +70°C <b>7820 – 7822:</b> -15° to +120°C

### Component Materials



External Components

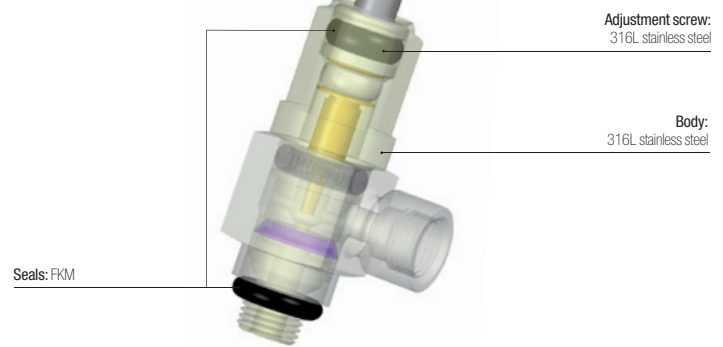

### Regulations

DI: 2002/95/EC (RoHS)  
 RG: 1907/2006 (REACH)  
 DI: 97/23/EC (PED)  
 RG: External Components: 21CFR (FDA)  
 RG: External Components: 1935/2004/EC

## Operation

### Exhaust Model with External Adjustment

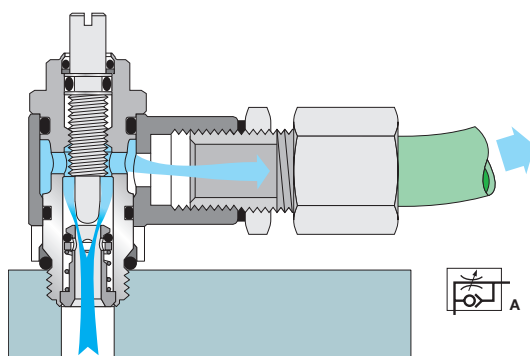

### Bi-Directional Model with External Adjustment

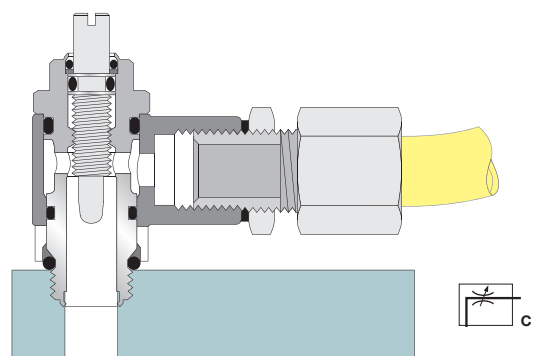

# Stainless Steel Flow Control Regulators

## 7810 Flow Regulator Exhaust, Male/Female BSPP and Metric Thread



Stainless steel 316L, FKM

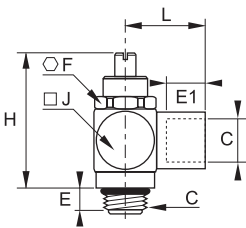

C		E	E1	F	H min	H max	J	L	kg
M5x0.8	<a href="#">7810 19 19</a>	4	4	8	22	26	9	11	0.011
G1/8	<a href="#">7810 10 10</a>	6	8	13	32	38	15	17	0.039
G1/4	<a href="#">7810 13 13</a>	9	12	17	35	40	18	24	0.072
G3/8	<a href="#">7810 17 17</a>	8	12	20	43	53	22	27	0.125
G1/2	<a href="#">7810 21 21</a>	9	15	23	60	71	28	31	0.261

## 7812 Bi-Directional Flow Regulator, Male/Female BSPP and Metric Thread



Stainless steel 316L, FKM

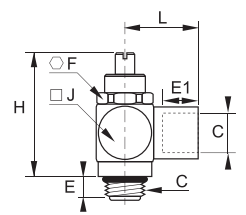

C		E	E1	F	H min	H max	J	L	kg
M5x0.8	<a href="#">7812 19 19</a>	4	4	8	22	26	9	11	0.290
G1/8	<a href="#">7812 10 10</a>	6	8	13	32	38	15	17	0.040
G1/4	<a href="#">7812 13 13</a>	9	12	17	35	40	18	24	0.074
G3/8	<a href="#">7812 17 17</a>	8	12	20	43	53	22	24	0.125
G1/2	<a href="#">7812 21 21</a>	9	15	23	60	71	28	31	0.261

## 7820 In-Line One-Way Flow Regulator, Female BSPP Thread



Stainless steel 316L, FKM

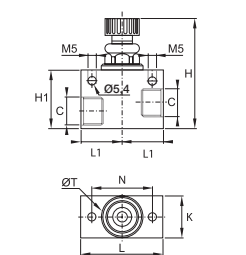

C	DN		H min	H max	H1	K	L	L1	N	ØT	kg
G1/8	7	<a href="#">7820 00 10</a>	47	52.5	30	20	40	20	30	20	0.175
G1/4	7	<a href="#">7820 00 13</a>	47	52.5	30	20	40	20	30	20	0.164
G3/8	9	<a href="#">7820 00 17</a>	56	65	35	25	50	25	36	25	0.298
G1/2	12	<a href="#">7820 00 21</a>	76	87	40	30	60	30	42	30	0.261

## 7822 Bi-Directional In-Line Flow Regulator, Female BSPP Thread



Stainless steel 316L, FKM

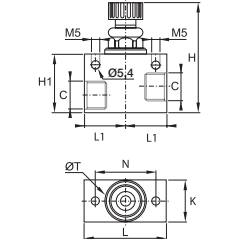

C	DN		H min	H max	H1	K	L	L1	N	ØT	kg
G1/8	7	<a href="#">7822 00 10</a>	48	52.5	30	20	40	20	30	20	0.176
G1/4	7	<a href="#">7822 00 13</a>	48	52.5	30	20	40	20	30	20	0.165
G3/8	9	<a href="#">7822 00 17</a>	58	65	35	25	50	25	36	20	0.296
G1/2	12	<a href="#">7822 00 21</a>	76	87	40	30	60	30	42	30	0.270

You will also find our range of stainless steel push-in fittings, compression fittings, valves and accessories in this catalogue.

# Flow Characteristics (at 6 bar)

## for Flow Control Regulators



**7010**  
**7011**  
**7012**

### 7010

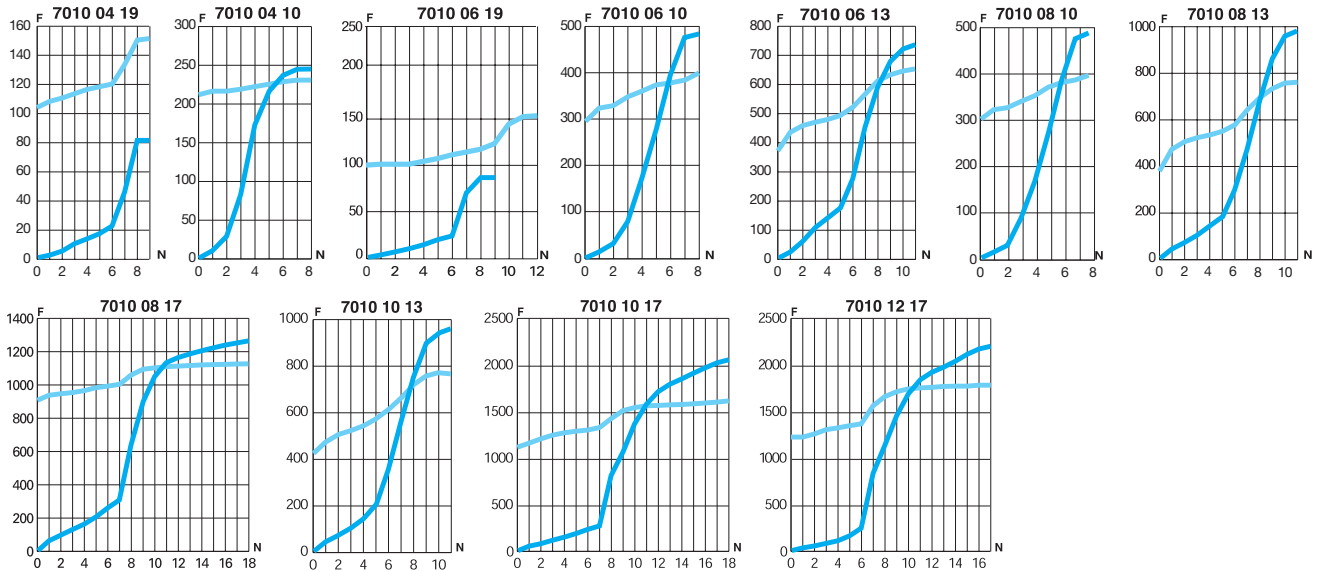

### 7011

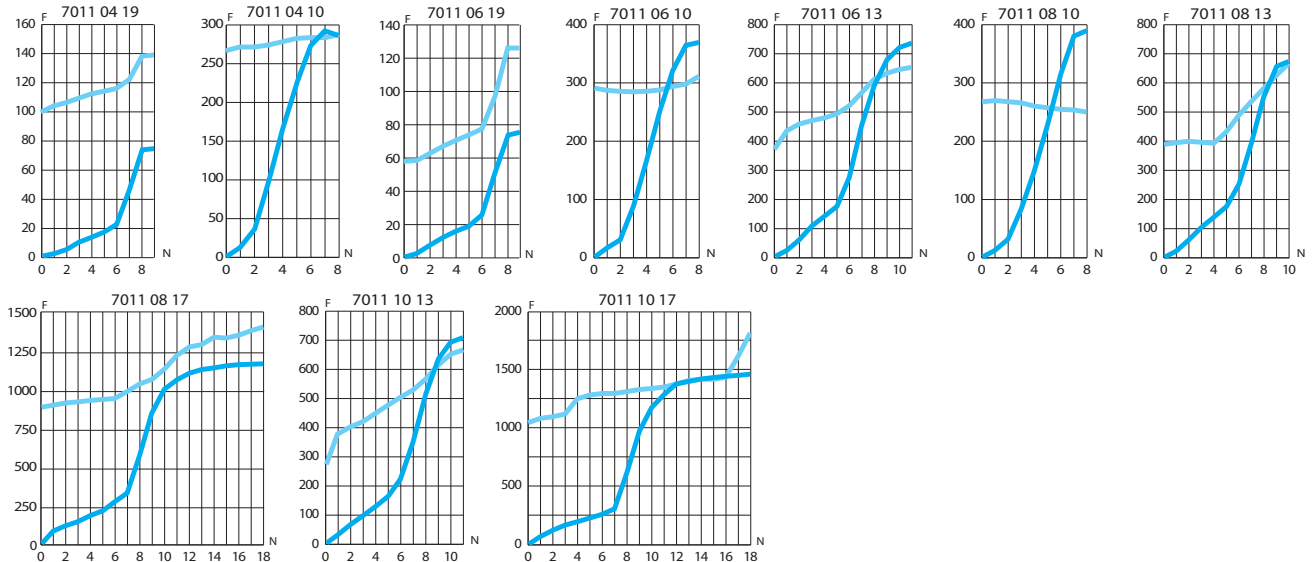

### 7012

#### Flow characteristics for model 7012:

- exhaust version (see model 7010, direction of adjustment)
- supply version (see model 7011, direction of adjustment)

6 bar

Direction of adjustment  
 Return

**F:** Flow in NI/min

**N:** Number of turns

# Flow Characteristics (at 6 bar)

## for Flow Control Regulators



**7060**  
**7061**  
**7062**

### 7060

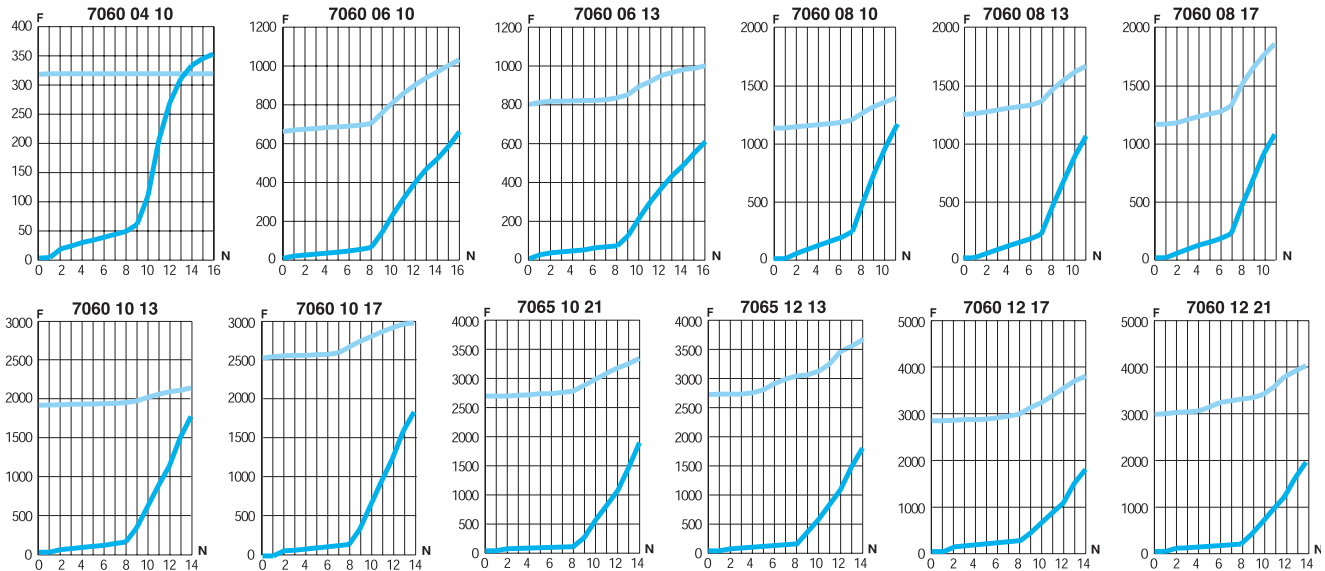

### 7061

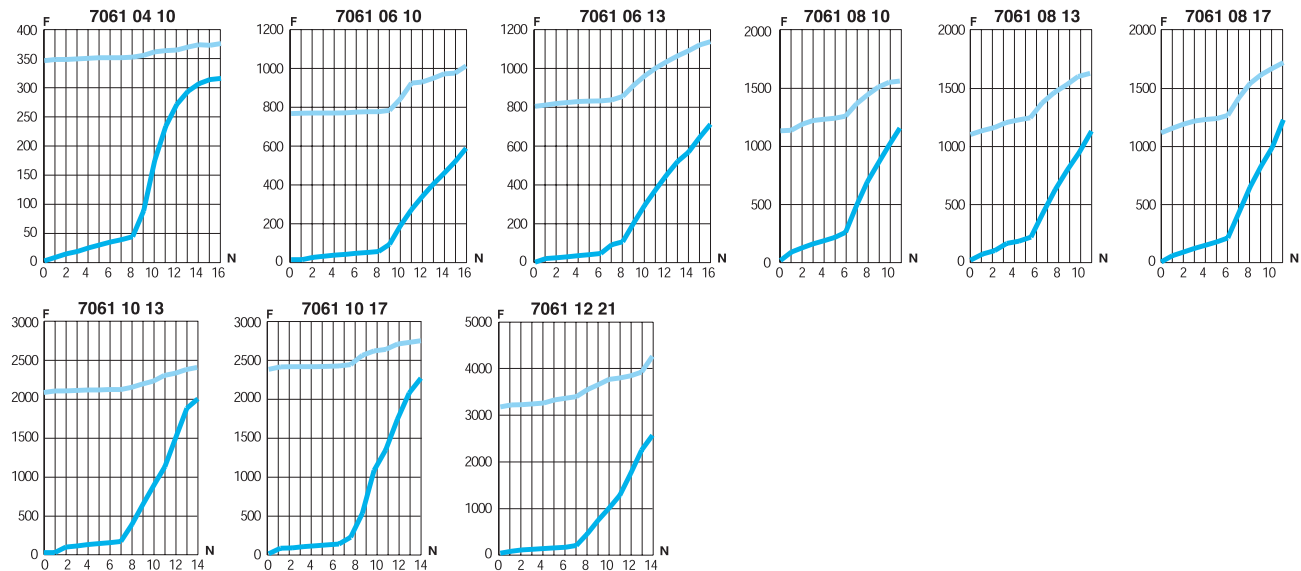

### 7062

#### Flow characteristics for model 7062:

- exhaust version (see model 7060, direction of adjustment)
- supply version (see model 7061, direction of adjustment)

# Flow Characteristics (at 6 bar)

## for Flow Control Regulators



**7660**  
**7669**  
**7662**

### 7660

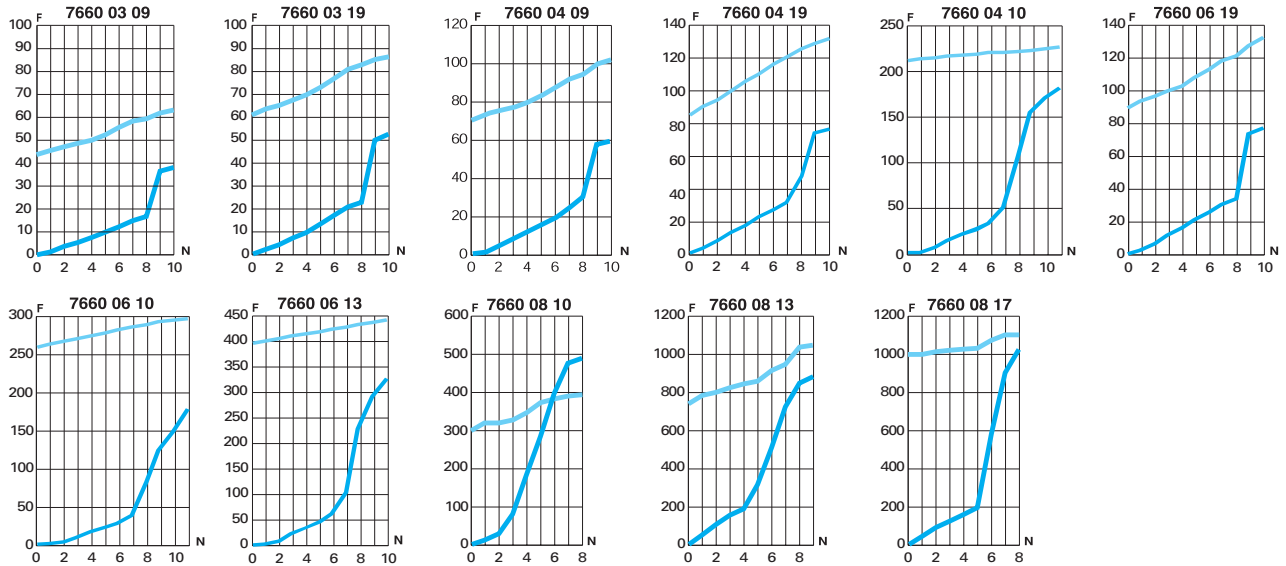

### 7669

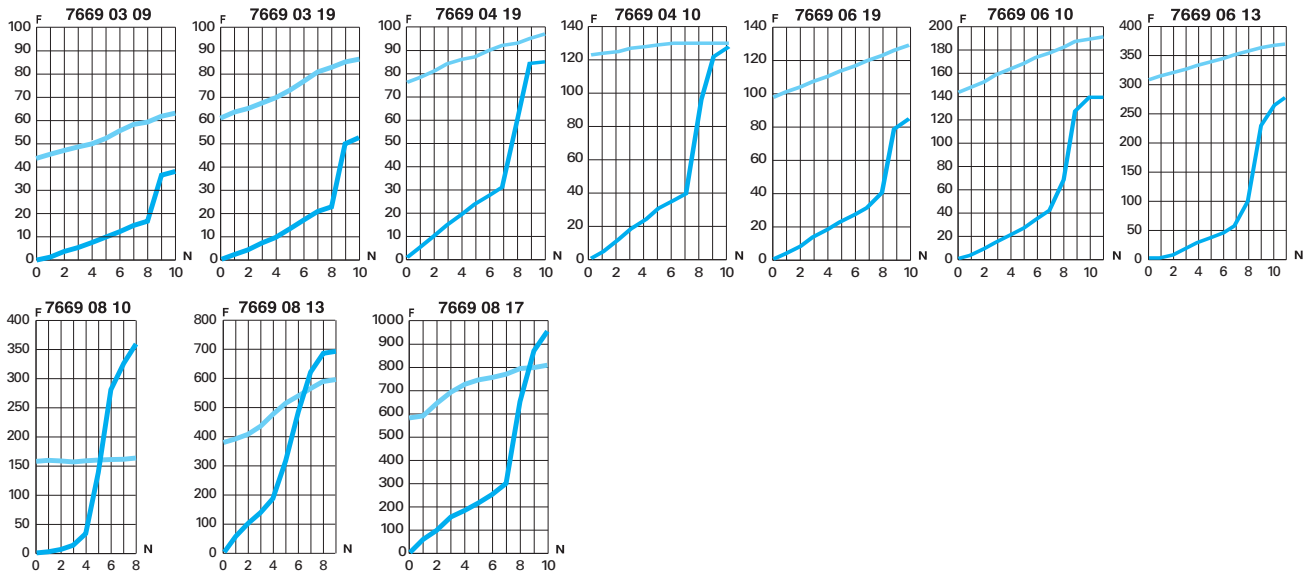

### 7662

#### Flow characteristics for model 7662:

- exhaust version: see model 7660, direction of adjustment
- supply version: see model 7669, direction of adjustment

6 bar

Direction of adjustment  
 Return

F: Flow in Nl/min

N: Number of turns

# Flow Characteristics (at 6 bar)

## for Flow Control Regulators



**7640**  
**7649**

### 7640

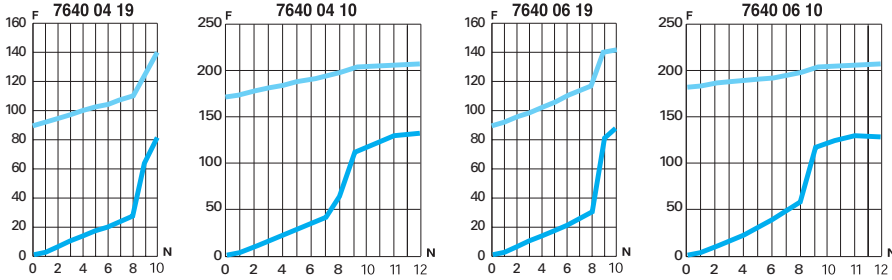

### 7649

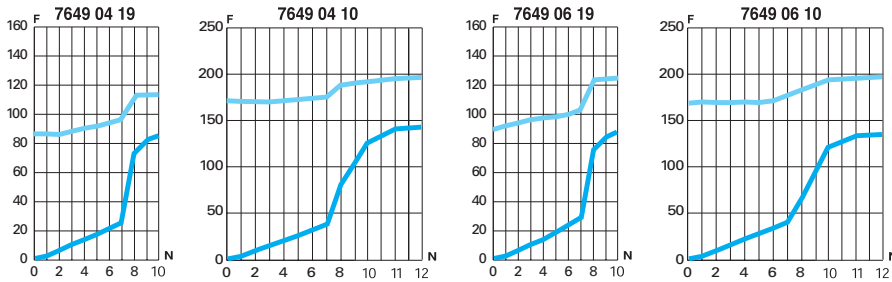

**7771**

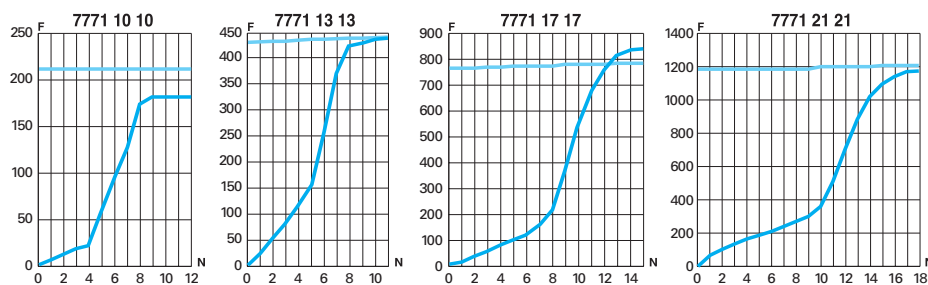

**7020**

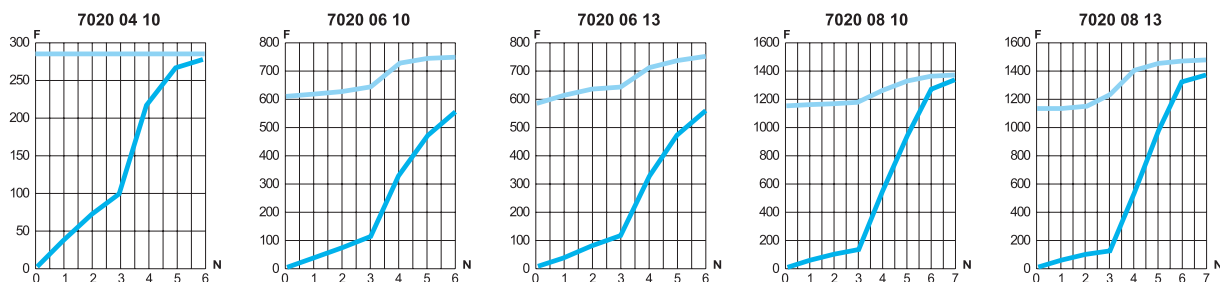

# Flow Characteristics (at 6 bar)

## for Flow Control Regulators



**7770**

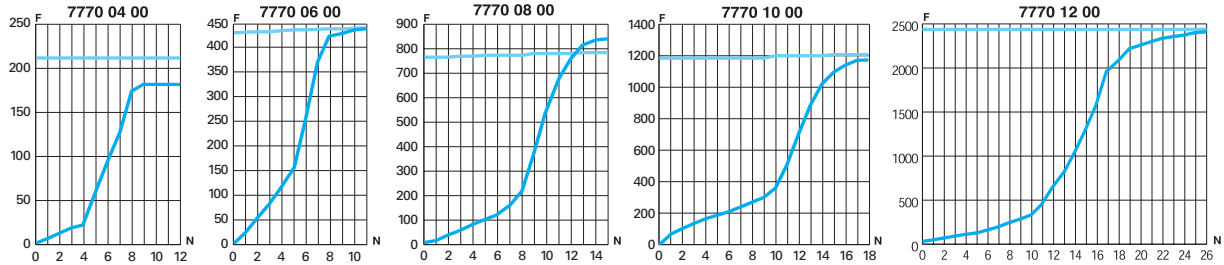

**7776**

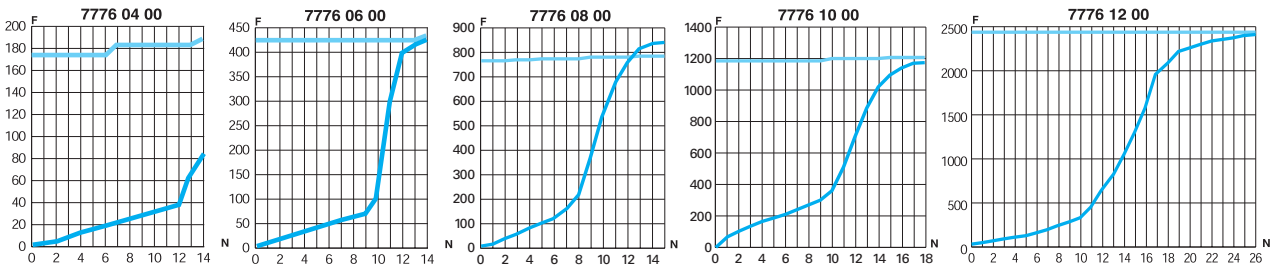

**7030**  
**7031**

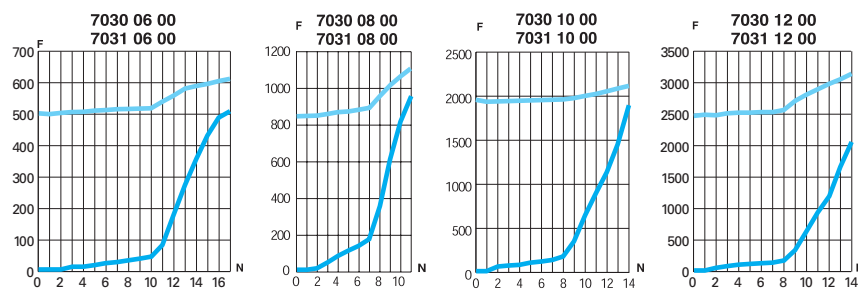

**7630**  
**7631**

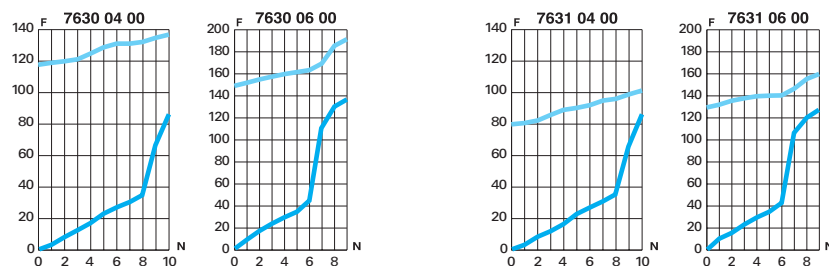

6 bar  
 Direction of adjustment  
 Return  
**F:** Flow in NI/min  
**N:** Number of turns

# Flow Characteristics (at 6 bar)

## for Flow Control Regulators



**7065**  
**7066**  
**7067**

### 7065

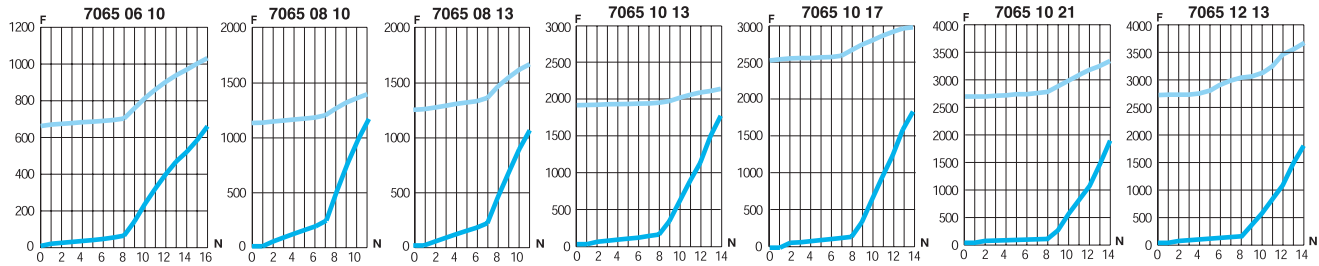

### 7066

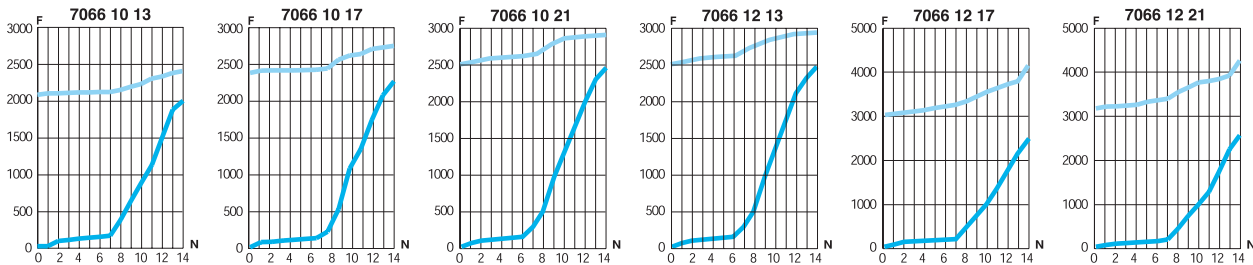

### 7067

#### Flow characteristics for model 7067:

- exhaust version: see model 7065, direction of adjustment
- supply version: see model 7066, direction of adjustment



**7665**  
**7668**

### 7665

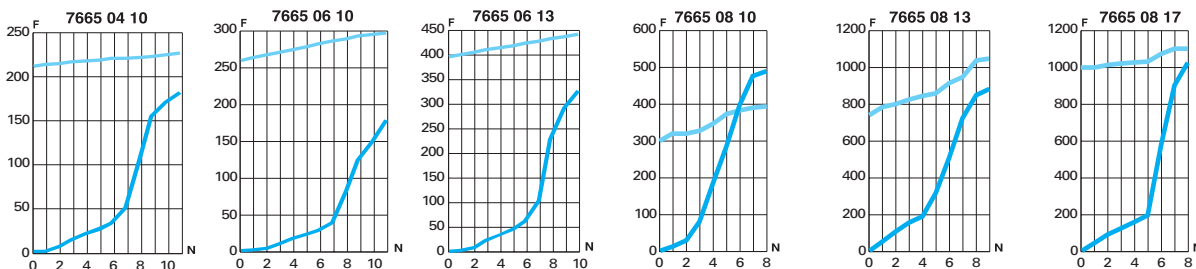

### 7668

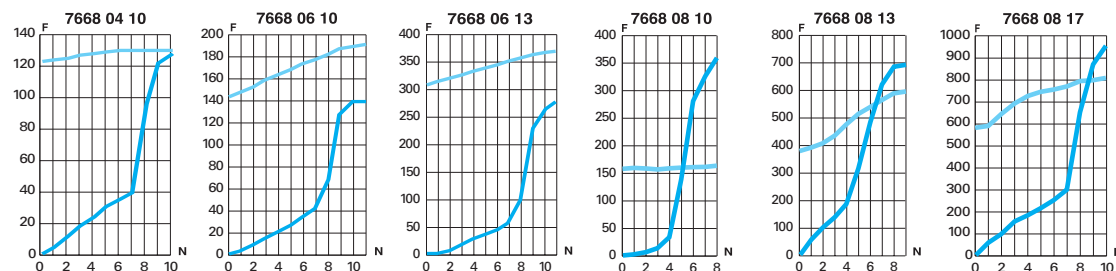

# Flow Characteristics (at 6 bar)

## for Flow Control Regulators



**7045**

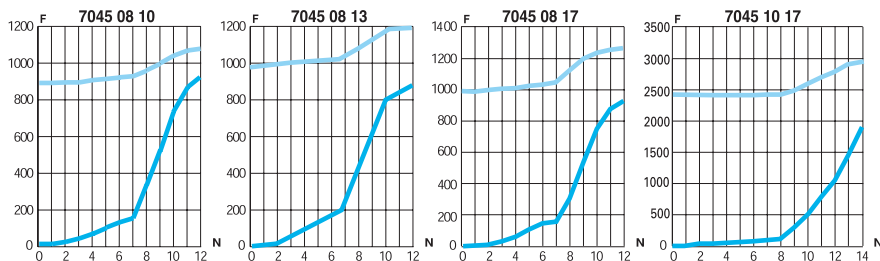

**7130**

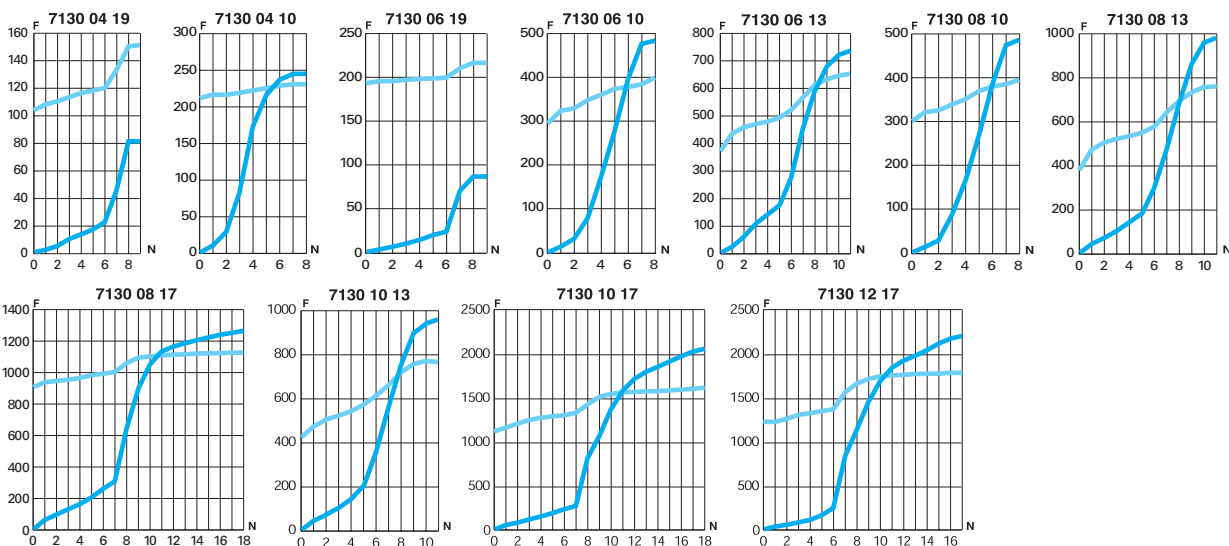

6 bar

Direction of adjustment  
 Return

**F:** Flow in NI/min

**N:** Number of turns

# Flow Characteristics (at 6 bar)

## for Flow Control Regulators



**7140**

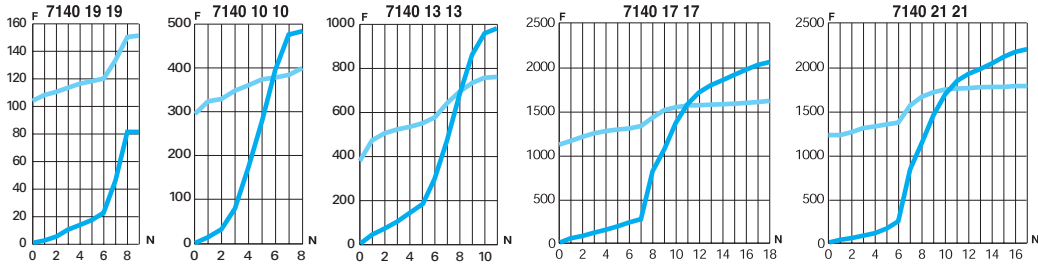

**7160**

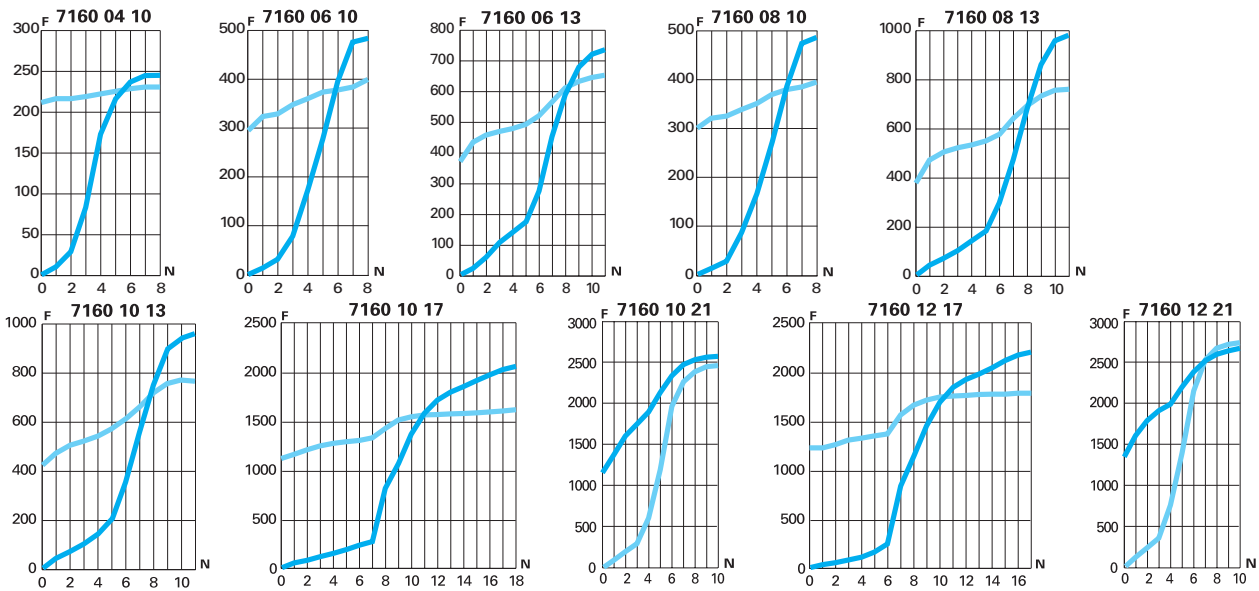

**7762**

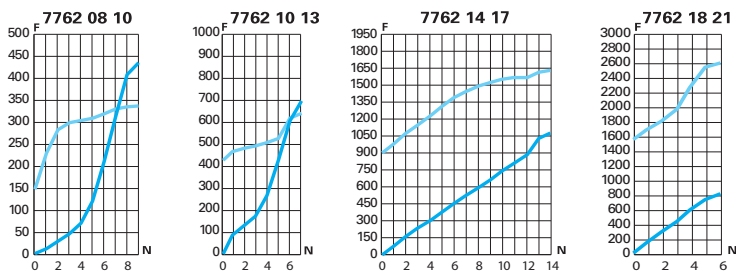

# Flow Characteristics (at 6 bar)

## for Flow Control Regulators



**7100**  
**7101**

### 7100

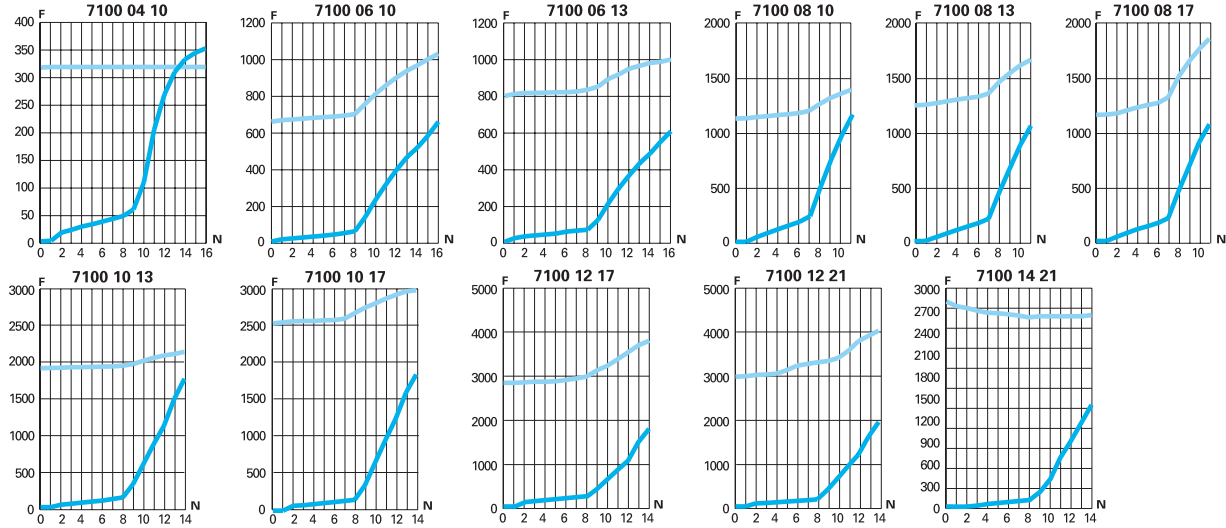

### 7101

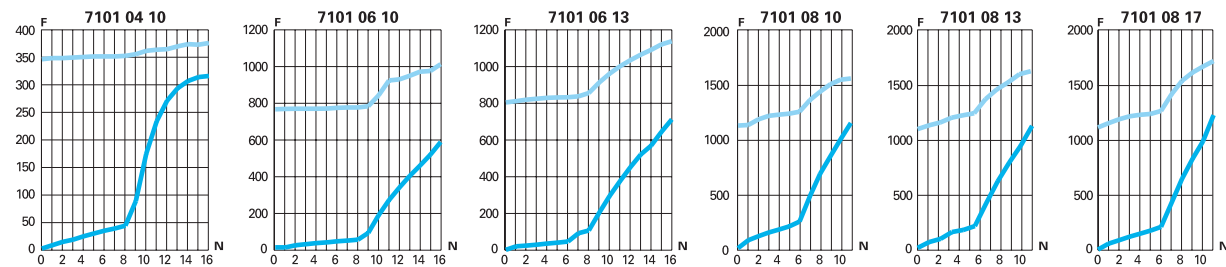

**7680**

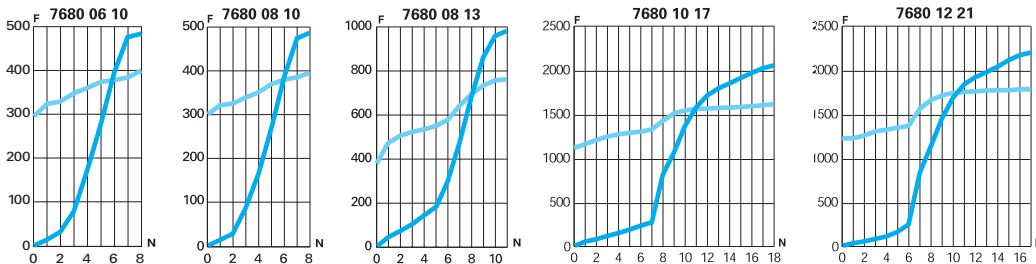

6 bar

Direction of adjustment  
 Return

**F:** Flow in NI/min  
**N:** Number of turns

# Flow Characteristics (at 6 bar)

## for Flow Control Regulators



**7180**

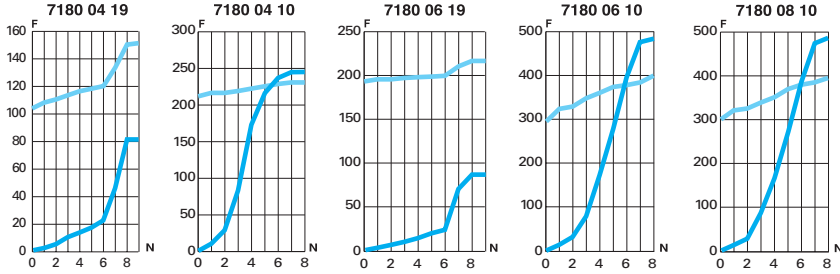

**7110**  
**7111**

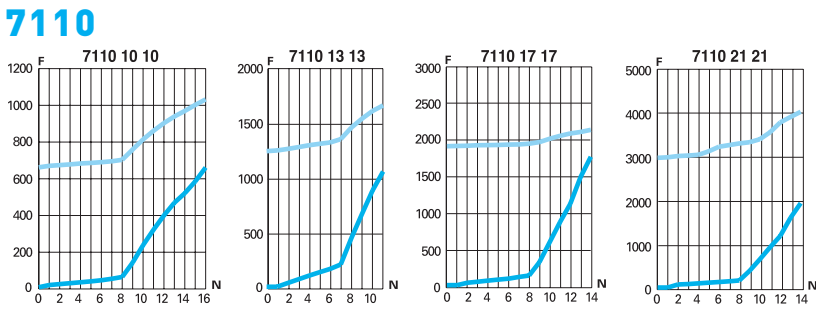

**7111**

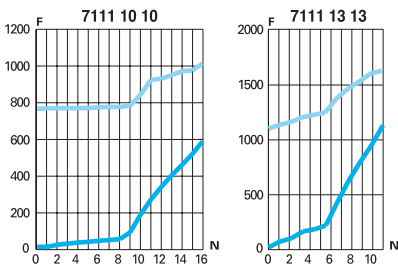

**7170**

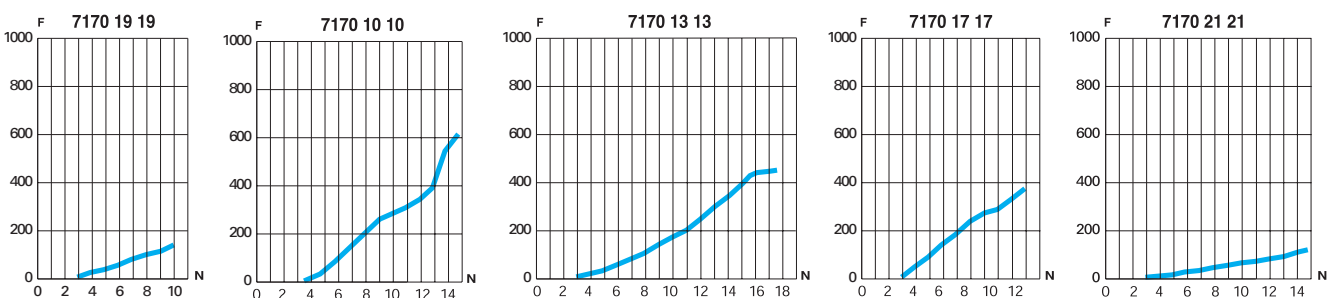

# Function Fittings Range

## Blocking Fittings

- 7880**  
BSPP  
Page 4-37
- 7881**  
BSPP  
Page 4-37
- 7885**  
BSPT  
Page 4-37
- 7886**  
BSPT  
Page 4-37
- 7883**  
BSPP  
Page 4-37



## Piloted Non-Return Valves

- 7892**  
BSPP  
Page 4-39
- 7894**  
BSPP  
Page 4-39



## Non-Return Valves

- 7996**  
Page 4-41
- 7984**  
**7994**  
BSPP/Metric  
Page 4-41
- 7985**  
**7995**  
BSPT  
Page 4-41



## Adjustable Non-Return Valves

- 7930**  
BSPP/Metric  
Page 4-43
- 7931**  
BSPP  
Page 4-43
- 7932**  
BSPP  
Page 4-43



## LIQUIfit® Non-Return Valves

- 7992**  
Page 4-45



## Stainless Steel Non-Return Valves

- 4890**  
BSPP  
Page 4-47
- 4891**  
BSPP  
Page 4-47
- 4892**  
BSPP  
Page 4-47
- 4895**  
NPT  
Page 4-47



## Soft Start Fittings

- 7860**  
BSPP  
Page 4-49
- 7870**  
BSPP  
Page 4-49
- 7861**  
BSPP  
Page 4-49
- 7871**  
BSPP  
Page 4-49



## Pneumatic Sensor Fittings

- 7818**  
BSPP/Metric  
Page 4-51
- 7828**  
BSPP/Metric  
Page 4-51



## Pressure Regulator Fittings

- 7300**  
BSPP  
Page 4-53



## Pressure Reducer Fittings

- 7318**  
BSPP  
Page 4-55
- 7471**  
BSPP  
Page 4-55
- 7316**  
Page 4-55
- 7416**  
BSPP  
Page 4-55
- 7000**  
Page 4-55
- 7000**  
Page 4-55



## Snap Fittings

- 7926**  
Page 4-57
- 7921**  
BSPP  
Page 4-57
- 7960**  
Page 4-57
- 7961**  
BSPP  
Page 4-57



## Manually-Operated Valves

- 7800**  
**7801**  
BSPP/Metric  
Page 4-59
- 7802**  
BSPP  
Page 4-59
- 0669**  
BSPP/Metric  
Page 4-59



# Function Fittings Range

## Metal Quick Exhaust Valves

**7970**  
BSPP/Metric  
Page 4-61

**7971**  
BSPP/BSPT  
Page 4-61

**7899**  
BSPP  
Page 4-61



## Silencers

**0674**  
BSPP/Metric  
Page 4-63

**0676**  
BSPP/Metric  
Page 4-63

**0670**  
BSPP  
Page 4-63

**0673**  
BSPP/Metric  
Page 4-63

**0675**  
BSPP/Metric  
Page 4-63

**0671**  
Page 4-64

**0677**  
BSPP  
Page 4-64

**0672**  
BSPP  
Page 4-64

**0682**  
BSPP  
Page 4-64

**0683**  
NPT  
Page 4-64



# Blocking Fittings

Blocking fittings, mounted in pairs on a cylinder, lock the piston by simultaneously **cutting off the supply and exhaust** when the pilot signal is removed.

## Product Advantages

### Optimum Performance

- Optimum flow: no effect on the performance of the cylinder
- Compact size
- Fully orientable for excellent flexibility in circuit installation
- 100% leak-tested in production
- Date coding to guarantee quality and traceability

### Robust

- Suitable for the most demanding environments
- Excellent corrosion and spark resistance to salt spray and sparks (threaded models)
- Proven push-in technology



**Applications**

- Robotics
- Machine Tools
- Textile
- Packaging
- Pneumatics
- Automotive Process

## Technical Characteristics

<b>Compatible Fluids</b>	Compressed air
<b>Working Pressure</b>	1 to 10 bar
<b>Working Temperature</b>	-20°C to +70°C

Connection	Supply Flow 6 bar	Pilot and depilot threshold depending on supply pressure				
		2 bar	4 bar	6 bar	8 bar	10 bar
ØD 6 and 8 mm, threads G1/8, G1/4, R1/8, R1/4	Pilot Pressure	2.40	2.90	3.30	3.60	4.00
	Depilot Pressure	1.50	1.80	2.15	2.40	2.80
ØD 10 and 12 mm, threads G3/8, G1/2, R3/8, R1/2	Pilot Pressure	2.70	3.20	3.50	3.80	4.10
	Depilot Pressure	1.40	1.80	2.10	2.40	2.70

### Component Materials

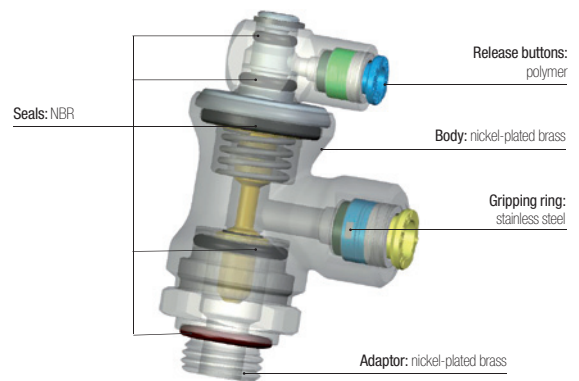

**Silicone-free**

### Regulations

- DI: 2002/95/EC (RoHS)
- DI: 97/23/EC (PED)
- RG: 1907/2006 (REACH)

## Operation

### Cylinder in Operation (pilot signal active)

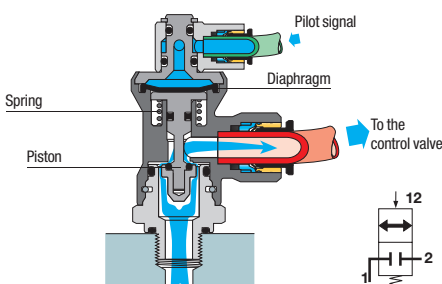

Pilot signal authorises movement

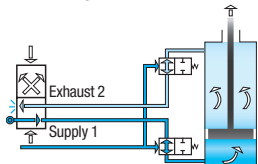

### Cylinder Blocked (pilot signal removed)

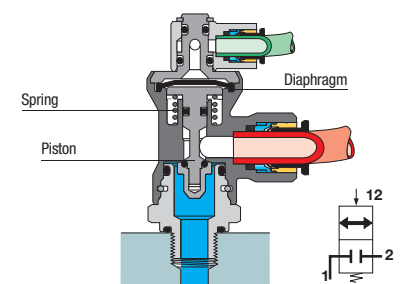

No signal blocks movement

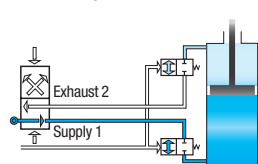

### Installation

Mounted in pairs, blocking fittings are installed directly on the cylinder. Being fully orientable, they offer excellent flexibility in the design and installation of pneumatic circuits.

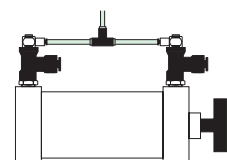
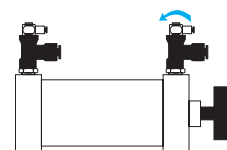

# Blocking Fittings

## 7880 Blocking Fitting, Male BSPP Thread



Nickel-plated brass, NBR

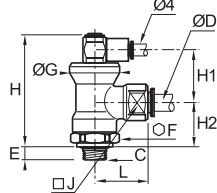

ØD	C		E	F	G	H	H1	H2	J	L	kg
6	G1/8	<a href="#">7880 06 10</a>	5.5	21	24	53	24.5	21	17	28	0.126
	G1/4	<a href="#">7880 06 13</a>	6.5	21	24	53	24.5	21	17	28	0.128
8	G1/4	<a href="#">7880 08 13</a>	6.5	21	24	53	24.5	21	17	28	0.122
	G3/8	<a href="#">7880 08 17</a>	7.5	21	24	53	24.5	21	17	28	0.127
10	G3/8	<a href="#">7880 10 17</a>	7.5	24	28	58	25	25	27	35	0.209
12	G1/2	<a href="#">7880 12 21</a>	9	24	28	58	25	25	27	37.5	0.222

## 7885 Blocking Fitting, Male BSPT Thread



Nickel-plated brass, NBR

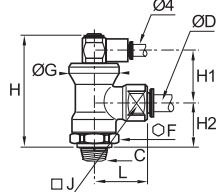

ØD	C		F	G	H	H1	H2	J	L	kg
6	R1/8	<a href="#">7885 06 10</a>	21	24	51.5	25	20	17	28	0.127
	R1/4	<a href="#">7885 06 13</a>	21	24	51.5	25	20	17	28	0.131
8	R1/4	<a href="#">7885 08 13</a>	21	24	51.5	25	20	17	28	0.126
	R3/8	<a href="#">7885 08 17</a>	21	24	51.5	25	20	17	28	0.130
10	R3/8	<a href="#">7885 10 17</a>	24	28	57	25	24	27	35	0.222
	R1/2	<a href="#">7885 12 21</a>	24	28	57	25	24	27	37.5	0.229

## 7881 Blocking Fitting, Male/Female BSPP Thread



Nickel-plated brass, NBR

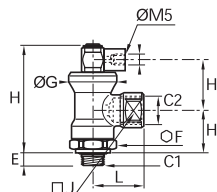

C1	C2		E	F	G	H	H1	H2	J	L	kg
G1/8	G1/4	<a href="#">7881 13 10</a>	5.5	21	24	53	24.5	21	17	25.5	0.118
G1/4	G1/4	<a href="#">7881 13 13</a>	6.5	21	24	53	24.5	21	17	25.5	0.119
G3/8	G3/8	<a href="#">7881 17 17</a>	7.5	24	28	58	25	25	27	34	0.211
G1/2	G1/2	<a href="#">7881 21 21</a>	9	24	28	58	25	25	27	40	0.226

## 7886 Blocking Fitting, Male/Female BSPT Thread



Nickel-plated brass, NBR

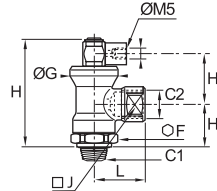

C1	C2		F	G	H	H1	H2	J	L	kg
R1/8	R1/4	<a href="#">7886 13 10</a>	21	24	51.5	25	20	17	26.5	0.121
R1/4	R1/4	<a href="#">7886 13 13</a>	21	24	51.5	25	20	17	26.5	0.126
R3/8	R3/8	<a href="#">7886 17 17</a>	24	28	57	25	24	27	34	0.225
R1/2	R1/2	<a href="#">7886 21 21</a>	24	28	57	25	24	27	40	0.240

## 7883 Blocker/Flow Regulator, Male BSPP Thread



Nickel-plated brass, technical polymer, NBR

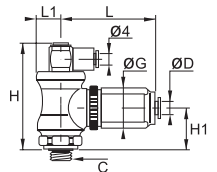

ØD	C		G	H	H1	L	L <sub>max</sub>	L1	kg
4	G1/8	<a href="#">7883 04 10</a>	21.5	53	21	46.5	52	12	0.166
	G1/4	<a href="#">7883 06 10</a>	21.5	53	21	46.5	52	12	0.163
6	G1/4	<a href="#">7883 06 13</a>	21.5	53	21	46.5	52	12	0.166
	G1/4	<a href="#">7883 08 13</a>	27	57.5	24.5	54	60	14	0.251
8	G3/8	<a href="#">7883 08 17</a>	27	57.5	24.5	54	60	14	0.254

Combination of blocking and flow regulation functions  
Working temperature: 0 to +70°C

# Piloted Non-Return Valves

Piloted non-return valves are designed to **protect installations**: if the compressed air supply is removed, they lock the air supply to the cylinder, thus maintaining it in position.

## Product Advantages

- System Protection** | Protection of your system  
 Control of inlet and outlet flow: cylinder operation optimised  
 Vent saves time on restart after maintenance operations (model 7894)
- 3 Functions in 1 Product** | A multi-purpose fitting:
  - piloted non-return valve
  - flow control regulator
  - manual exhaust
 All-in-one product: integrated fittings for the control and supply
- Flexible Operation** | Orientable and adjustable through 3 axes  
 Can be integrated into any installation configuration  
 Push-in connection for quicker and more reliable installation  
 Mounted in pairs directly on the cylinder



Applications

- Pneumatics
- Assembly
- Robotics
- Machine Tools
- Packaging
- Handling
- Automotive Process

## Technical Characteristics

<b>Compatible Fluids</b>	Compressed air
<b>Working Pressure</b>	1 to 10 bar
<b>Working Temperature</b>	-5°C to +60°C
<b>Cracking Pressure</b>	0.3 bar

### Component Materials

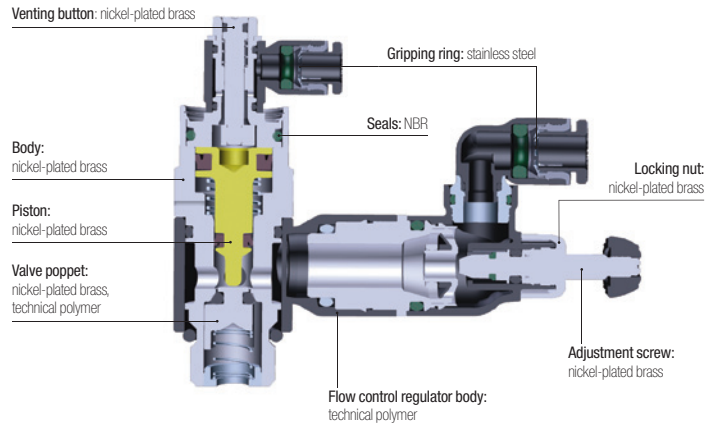

Silicone-free

### Regulations

DI: 2002/95/EC (RoHS)  
 RG: 1907/2006 (REACH)  
 DI: 97/23/EC (PED)

## Operation

### Normal Operation

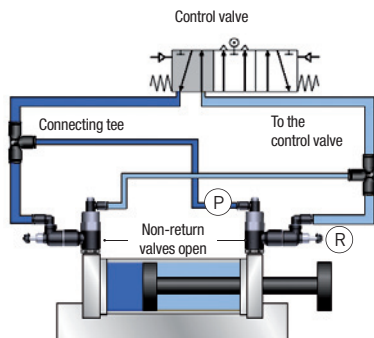

Pilot signal (P)  
 Regulation of cylinder rod speed (R)

### Emergency Stop or Pressure Drop

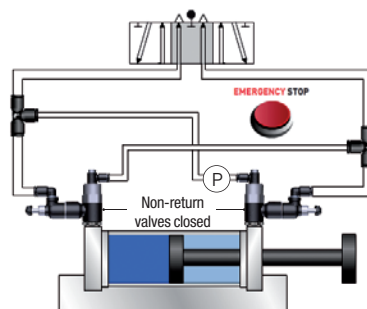

Drop/removal of pilot pressure (P) = cylinder rod locked

### Venting Operation

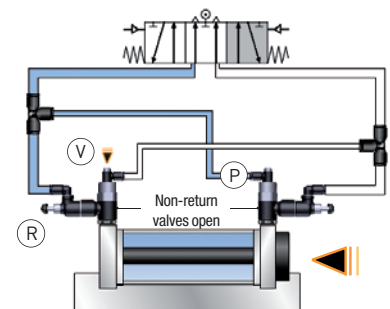

Venting (V) returns the cylinder rod to the start position, employing the pressure chamber through the flow regulator (R) and pilot line (P)

# Piloted Non-Return Valves

## 7892 Piloted Non-Return Valve, Male BSPP Thread



Technical polymer, nickel-plated brass, NBR

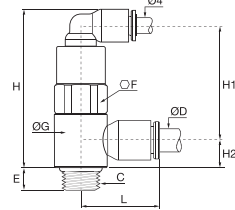

ØD	C		E	F	G	H	H1	H2	L	kg
6	G1/8	<a href="#">7892 06 10</a>	6	13	14	42	30	7	21	0.020
	G1/4	<a href="#">7892 06 13</a>	9	17	18.5	45	32	9	23	0.042
8	G1/8	<a href="#">7892 08 10</a>	6	13	14	42	29	9	25	0.020
	G1/4	<a href="#">7892 08 13</a>	9	17	18.5	45	32	9	27	0.042
10	G3/8	<a href="#">7892 08 17</a>	6	20	22.5	57	41	11	28	0.093
	G3/8	<a href="#">7892 10 17</a>	6	20	22.5	57	41	11	31	0.144
12	G1/2	<a href="#">7892 10 21</a>	10	24	28	63	47	16	36	0.109
12	G1/2	<a href="#">7892 12 21</a>	10	24	28	63	47	16	36	0.150

## 7894 Piloted Non-Return Valve with Flow Regulator and Exhaust, Male BSPP Thread



Technical polymer, nickel-plated brass, NBR

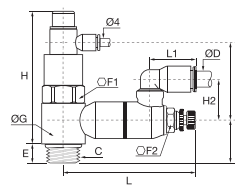

ØD	C		E	F1	F2	G	H	H1	H2	H3	L	L <sub>max</sub>	L1	kg
6	G1/8	<a href="#">7894 06 10</a>	6	13	8	14	46	7	24	31	48.5	51	16	0.041
	G1/4	<a href="#">7894 06 13</a>	9	17	10	18.5	49	11	18	31	59.5	65	17	0.067
8	G1/8	<a href="#">7894 08 10</a>	6	13	8	14	46	7	27	31	48.5	51	22	0.051
	G1/4	<a href="#">7894 08 13</a>	9	17	10	18.5	49	11	23	31	59.5	65	23	0.068
10	G3/8	<a href="#">7894 08 17</a>	7	20	14	22.5	69	13	21	40	67.5	73	23	0.060
	G3/8	<a href="#">7894 10 17</a>	7	20	14	22.5	69	13	29	40	67.5	73	26	0.061
12	G1/2	<a href="#">7894 10 21</a>	9	24	17	28	76	12.5	26	47	74	81	26	0.234
	G1/2	<a href="#">7894 12 21</a>	9	24	17	28	76	12.5	27	47	74	81	30	0.237

## 3104 Unequal Tee



Technical polymer, NBR

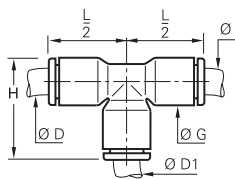

ØD	ØD1		G	H	L/2	kg
6	4	<a href="#">3104 06 04</a>	10.5	22.5	17.5	0.005
8	4	<a href="#">3104 08 04</a>	13.5	29	22.5	0.014
10	4	<a href="#">3104 10 04</a>	16	33	26	0.027
12	4	<a href="#">3104 12 04</a>	19	39	31	0.034

Model	Pilot and depilot threshold					
		2 bar	4 bar	6 bar	8 bar	10 bar
G1/8	Pilot Pressure	1.2	1.72	2.44	2.96	3.56
	Depilot Pressure	0.56	0.96	1.12	1.76	2.12
G1/4	Pilot Pressure	0.92	1.52	2.12	2.68	3.28
	Depilot Pressure	0.64	1.16	1.68	2.16	2.64
G3/8	Pilot Pressure	1.12	1.84	2.56	3.32	4.08
	Depilot Pressure	0.64	1.04	1.44	1.84	2.36
G1/2	Pilot Pressure	1.04	1.60	2.12	2.76	3.88
	Depilot Pressure	0.76	1.28	1.76	2.20	2.72

Maximum Flow at 6 bar (NI/min)	7894 06 10	7894 06 13	7894 08 10	7894 08 13	7894 08 17	7894 10 17	7894 10 21	7894 12 21
Direction of Adjustment	250	475	240	585	875	940	1535	1560
Return	365	620	355	815	1085	1205	1860	1940

# Non-Return Valves

Non-return valves allow compressed air to flow in one direction and prevent it from flowing in the other. Fitted upstream of the circuit to be protected, they provide **total protection**.

## Product Advantages

### Variety of Applications

Wide range  
Push-in connection: ease of use  
Available in threaded or push-in version

### Powerful Design

Lip seals for improved sealing performance  
Excellent vibration resistance  
Compact  
Lightweight  
Symbol showing the operating direction of flow  
Safe installation with colour codes:  

- green push-button: supply version
- red push-button: exhaust version



Automotive Process  
Robotics  
Vacuum  
Textile  
Semi-Conductors  
Packaging  
Pneumatics

Applications

## Technical Characteristics

Compatible Fluids	Compressed air	
Working Pressure	1 to 10 bar	
Working Temperature	0°C to +70°C	
Cracking Pressure	0.3 bar	
Flow Characteristics (NI/min)	<b>Model</b>	<b>Flow at 6 bar</b>
	4 mm	350
	6 mm	670
	8 mm	1080
	10 mm	2230
12 mm	2300	

### Component Materials

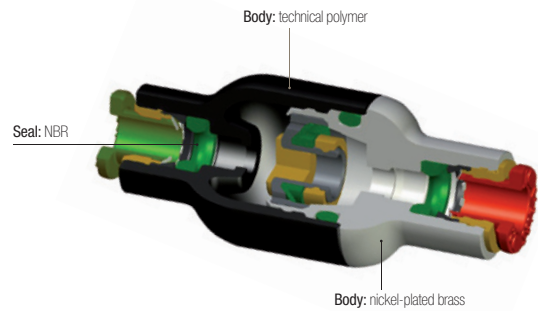

Silicone-free

### Regulations

DI: 2002/95/EC (RoHS)  
RG: 1907/2006 (REACH)  
DI: 97/23/EC (PED)

## Operation

In-Line Version	Supply Version	Exhaust Version	Installation Diagram
<p>Non-return valve</p>	<p>Non-return valve</p> <p>Models 7984-7985</p>	<p>Non-return valve</p> <p>Models 7994-7995</p>	

# Non-Return Valves

## 7996 In-Line Equal Non-Return Valve



Technical polymer, nickel-plated brass, NBR

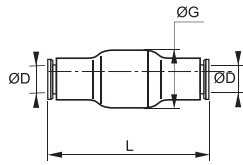

ØD		G	L	kg
4	<a href="#">7996 04 00</a>	16	38.5	0.008
6	<a href="#">7996 06 00</a>	16	41	0.013
8	<a href="#">7996 08 00</a>	19	51.5	0.017
10	<a href="#">7996 10 00</a>	23	63.5	0.070
12	<a href="#">7996 12 00</a>	23	66.5	0.050

## 7984 In-Line Non-Return Valve, Supply, Male BSPP and Metric Thread



Technical polymer, nickel-plated brass, NBR

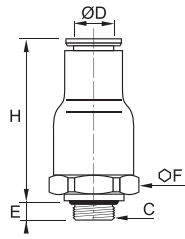

ØD	C		E	F	H	kg
4	M5x0.8	<a href="#">7984 04 19</a>	3	9	32	0.008
	G1/8	<a href="#">7984 04 10</a>	5	16	28.5	0.015
6	G1/8	<a href="#">7984 06 10</a>	5	16	30.5	0.015
	G1/4	<a href="#">7984 06 13</a>	5.5	16	30.5	0.015
8	G1/8	<a href="#">7984 08 10</a>	5	19	36	0.021
	G1/4	<a href="#">7984 08 13</a>	5.5	19	36	0.023
10	G3/8	<a href="#">7984 10 17</a>	5.5	23	42	0.047
	G3/8	<a href="#">7984 12 17</a>	5.5	23	42	0.010
12	G1/2	<a href="#">7984 12 21</a>	7.5	23	44	0.041

## 7994 In-Line Non-Return Valve, Exhaust, Male BSPP and Metric Thread



Technical polymer, nickel-plated brass, NBR

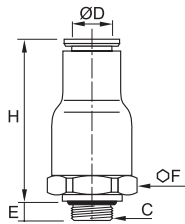

ØD	C		E	F	H	kg
4	M5x0.8	<a href="#">7994 04 19</a>	3	9	32	0.790
	G1/8	<a href="#">7994 04 10</a>	5	16	28.5	0.018
6	G1/8	<a href="#">7994 06 10</a>	5	16	30.5	0.015
	G1/4	<a href="#">7994 06 13</a>	5.5	16	30.5	0.015
8	G1/8	<a href="#">7994 08 10</a>	5	19	36	0.023
	G1/4	<a href="#">7994 08 13</a>	5.5	19	36	0.023
10	G3/8	<a href="#">7994 10 17</a>	5.5	23	42	0.050
	G3/8	<a href="#">7994 12 17</a>	5.5	23	42	0.043
12	G1/2	<a href="#">7994 12 21</a>	7.5	23	44	0.045

## 7985 In-Line Non-Return Valve, Supply, Male BSPT Thread



Technical polymer, nickel-plated brass, NBR

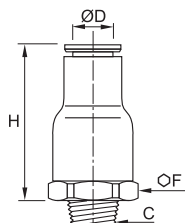

ØD	C		F	H	kg
4	R1/8	<a href="#">7985 04 10</a>	16	28.5	0.016
	R1/8	<a href="#">7985 06 10</a>	16	30.5	0.016
6	R1/4	<a href="#">7985 06 13</a>	16	30.5	0.021
	R1/8	<a href="#">7985 08 10</a>	19	36	0.022
8	R1/4	<a href="#">7985 08 13</a>	19	36	0.020
	R3/8	<a href="#">7985 10 17</a>	23	42	0.049
10	R3/8	<a href="#">7985 12 17</a>	23	42	0.042
	R1/2	<a href="#">7985 12 21</a>	23	44	0.048

Pre-coated thread

## 7995 In-Line Non-Return Valve, Exhaust, Male BSPT Thread



Technical polymer, nickel-plated brass, NBR

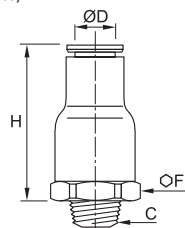

ØD	C		F	H	kg
4	R1/8	<a href="#">7995 04 10</a>	16	28.5	0.015
	R1/8	<a href="#">7995 06 10</a>	16	30.5	0.016
6	R1/4	<a href="#">7995 06 13</a>	16	30.5	0.022
	R1/8	<a href="#">7995 08 10</a>	19	36	0.022
8	R1/4	<a href="#">7995 08 13</a>	19	36	0.026
	R3/8	<a href="#">7995 10 17</a>	23	42	0.048
10	R3/8	<a href="#">7995 12 17</a>	23	42	0.042
	R1/2	<a href="#">7995 12 21</a>	23	44	0.048

Pre-coated thread

# Nickel-Plated Brass Adjustable Non-Return Valves

These nickel-plated brass adjustable non-return valves, suitable for **harsh environments**, allow compressed air to flow in one direction and prevent flow in the other. This product incorporates **precise adjustment** of opening pressure for greater flexibility.

## Product Advantages

- Robust** | Excellent resistance to abrasion and corrosion  
Developed for the food process industry
- Optimised Inventory Management** | A single valve for multiple opening pressure settings  
Limits the number of versions  
Flexibility of use
- Protection & Safety** | Maintains downstream pressure if upstream pressure drops  
Designed with locking nut to protect initial setting in the event of:
  - vibration
  - intensive use
  - accidental handling
 Adjustment and locking of the non-return valve cracking pressure with two different Allen keys prevents the settings from being accidentally changed  
Smooth external profile to facilitate cleaning in situ  
Maximum constant flow guaranteed whatever the setting of the cracking pressure



**Applications**

Printing  
Machine Tools  
Food Process  
Petrochemical  
Textile  
Automotive Process  
Chemical

## Technical Characteristics

<b>Compatible Fluids</b>	Compressed air					
<b>Working Pressure</b>	0 to 12 bar					
<b>Working Temperature</b>	-20°C to +80°C					
<b>Cracking Pressure</b>	Threads		0 to 4 turns (values given as an example only)			
	M5x0.8 - G1/8 - G1/4		1 to 0.10 bar			
	G3/8		1 to 0.15 bar			
	G1/2		1 to 0.20 bar			
<b>Max. Tightening Torques</b>	Threads	M5x0.8	G1/8	G1/4	G3/8	G1/2
	daN.m	0.16	0.8	1.2	3	3.5

### Component Materials

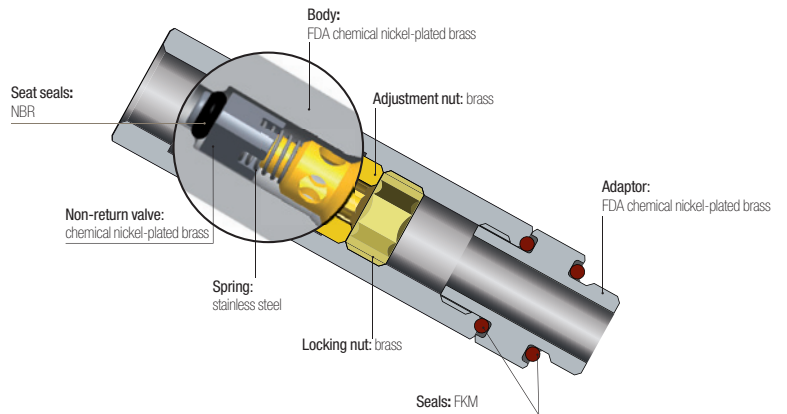

**Silicone-free**

### Regulations

- DI: 2002/95/EC (RoHS)
- RG: External Components: 21CFR (FDA)  
(seal: § 177.2600, nickel: §184.1537, grease: NSF H1)
- RG: 1935/2004 (external surface flow  $\geq$  0.02 litre per hour)
- DI: 2006/42/EC (external surface Pa < 0.8  $\mu$ m)
- RG: 1907/2006 (REACH)

## Operation

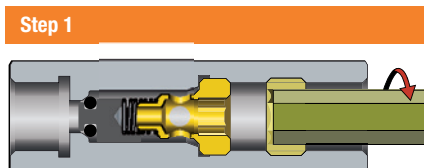

Unscrew the locking nut with an Allen key.

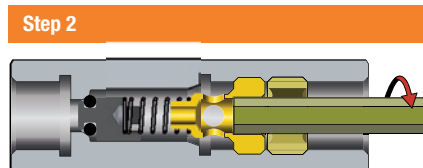

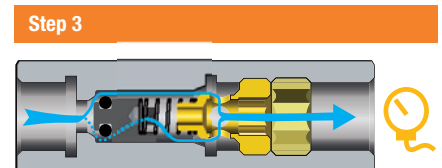

Unscrew the adjustment nut with a smaller Allen key to adjust the cracking pressure. The number of turns adjusts the cracking pressure from 1 bar to 0.10 bar.



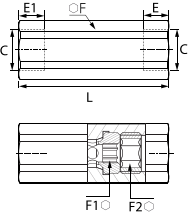

Tighten the locking nut with the Allen key to lock the cracking pressure setting. Then, control the pressure with a pressure gauge downstream.

# Nickel-Plated Brass Adjustable Non-Return Valves

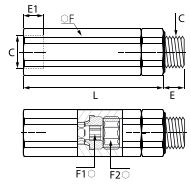

## 7930 Adjustable Check Valve, Double Female BSPP and Metric Thread

			<b>C</b>	<b>E</b>	<b>E1</b>	<b>F</b>	<b>F1</b>	<b>F2</b>	<b>L</b>	<b>kg</b>	
			M5x0.8	7930 19 19	8	4	13	4	6	49	0.055
			G1/8	7930 10 10	8	6	13	4	6	45	0.033
			G1/4	7930 13 13	10	7.5	16	6	8	54	0.073
			G3/8	7930 17 17	11	8.5	20	8	10	61.5	0.163
			G1/2	7930 21 21	13	10	24	10	12	73	0.171

## 7931 Adjustable Check Valve Supply, Male/Female BSPP Thread

			<b>C</b>	<b>E</b>	<b>E1</b>	<b>F</b>	<b>F1</b>	<b>F2</b>	<b>L</b>	<b>kg</b>	
			G1/8	7931 10 10	5.5	6	13	4	6	51.5	0.043
			G1/4	7931 13 13	6.5	7.5	16	6	8	61.5	0.208
			G3/8	7931 17 17	7.5	8.5	20	8	10	70	0.125
			G1/2	7931 21 21	9	10	24	10	12	82.5	0.212

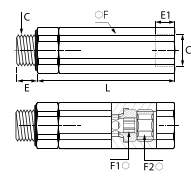
## 7932 Adjustable Check Valve Exhaust, Male/Female BSPP Thread

			<b>C</b>	<b>E</b>	<b>E1</b>	<b>F</b>	<b>F1</b>	<b>F2</b>	<b>L</b>	<b>kg</b>	
			G1/8	7932 10 10	5.5	8	13	4	6	51.5	0.009
			G1/4	7932 13 13	6.5	10	16	6	8	61.5	0.058
			G3/8	7932 17 17	7.5	11	20	8	10	70	0.123
			G1/2	7932 21 21	9	13	24	10	12	82.5	0.212

# LIQUIfit® Non-Return Valves

LIQUIfit® non-return valves meet the requirements for conveying **beverages**. They allow flow in one direction and prevent any return flow. Fitted in the circuit, they provide **total protection**.

## Product Advantages

### Suitable for Beverage Applications

Fully compatible for use with water, beverages and liquid foodstuffs (liquids and gas)  
Very low cracking threshold  
Excellent chemical compatibility  
Resistant to cleaning products  
Hygienic design with smooth surfaces  
Fluid direction indicated  
EPDM sealing technology



Water Softeners  
Water Treatment  
Water Purification  
Drinks Dispensers  
Hot & Cold Water Systems

Applications

## Technical Characteristics

Compatible Fluids	Water, beverages, liquid foodstuffs
Working Pressure	1 to 10 bar
Working Temperature	0°C to +65°C
Cracking Pressure	< 0.05 bar

### Component Materials

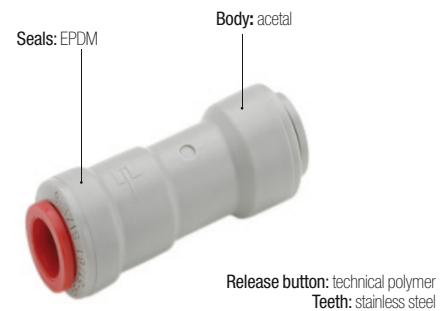

Silicone-free

### Regulations

DI: 2002/95/EC (RoHS), 2011/65/EC  
FDA: 21 CFR 177.1550  
NSF 51 (referenced material)  
NSF 61  
RG: 1907/2006 (REACH)

# LIQUIfit® Non-Return Valves

**7992**

Single Non-Return Valve



Acetal, EPDM

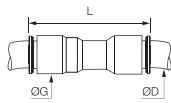

ØD		G	L	kg
1/4	<a href="#">7992 56 00WP2</a>	17	51	0.008
3/8	<a href="#">7992 60 00WP2</a>	20	55	0.011

## Associated Products

The full range of LIQUIfit® products can be found in this catalogue:

- Push-in fittings for metric and inch tubing (Chapter 1)
- Valves (Chapter 6)

To complement the LIQUIfit® range, Parker Legris Advanced PE tubing (Chapter 3) is suited to the most demanding environments, approved for permanent contact with beverage and food products, as well as for water treatment.

# Stainless Steel Non-Return Valves

Stainless steel non-return valves are ideally suited to **harsh environments** and for conveying **many industrial fluids**. These products allow fluids to flow in one direction and prevent them from flowing in the other.

## Product Advantages

**Demanding Environments** | Robust design  
 Suitable for use with many chemicals or in corrosive environments  
 Compatible with many fluids

**Compact & Versatile** | Reduced dimensions  
 Smooth external surfaces contribute to equipment cleanliness  
 Flow direction symbol protects against incorrect installation  
 Hexagonal body to facilitate installation



**Applications**  
 Pneumatics  
 Machine Tools  
 Food Process  
 Printing  
 Chemical  
 Textile  
 Automotive Process

## Technical Characteristics

<b>Compatible Fluids</b>	Many fluids
<b>Working Pressure</b>	0.5 to 40 bar
<b>Working Temperature</b>	-20°C to +180°C

Flow Characteristics	Threads	NI/min	Kv
	G1/8	18.88	1.60
G1/4	19.91	1.69	
G3/8	35.54	3.01	
G1/2	36.50	3.10	
G3/4	65.86	5.59	
G1	92.60	7.86	

<b>Cracking Pressure</b>	0.25 bar
--------------------------	----------

### Component Materials

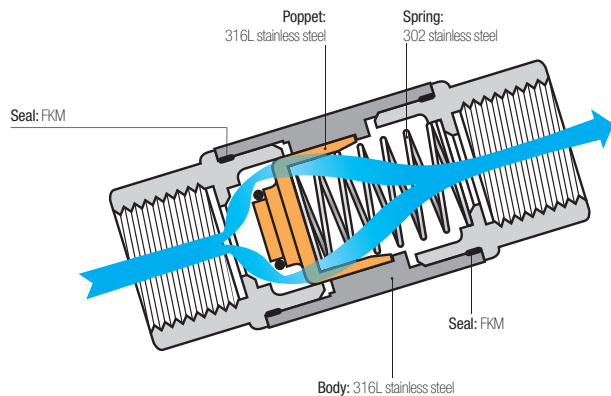

**Silicone-free**

### Regulations

DI: 2002/95/EC (RoHS)  
 RG: 1907/2006 (REACH)  
 DI: 97/23/EC (PED)

# Stainless Steel Non-Return Valves

## 4890 Non-Return Valve, Female BSPP Thread



Stainless steel 316L, FKM

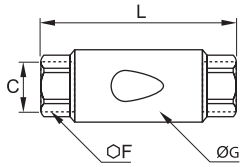

C	DN		F	G	L	kg
G1/8	10	<a href="#">4890 10 10</a>	17	22	50	0.083
G1/4	10	<a href="#">4890 13 13</a>	17	22	50	0.074
G3/8	15	<a href="#">4890 17 17</a>	22	30	67	0.183
G1/2	15	<a href="#">4890 21 21</a>	24	30	71	0.209
G3/4	20	<a href="#">4890 27 27</a>	32	42	84	0.289
G1	25	<a href="#">4890 34 34</a>	38	42	90	0.519

## 4891 Non-Return Valve, Supply, Male BSPP Thread/Exhaust, Female BSPP Thread



Stainless steel 316L, FKM

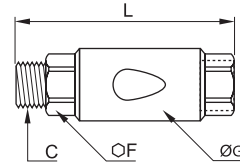

C	DN		F	G	L	kg
G1/8	10	<a href="#">4891 10 10</a>	17	22	56	0.100
G1/4	10	<a href="#">4891 13 13</a>	17	22	58	0.082
G3/8	15	<a href="#">4891 17 17</a>	22	30	75	0.189
G1/2	15	<a href="#">4891 21 21</a>	24	30	79	0.209
G3/4	20	<a href="#">4891 27 27</a>	32	42	84	0.300
G1	25	<a href="#">4891 34 34</a>	38	42	102	0.519

## 4892 Non-Return Valve, Supply, Female BSPP Thread/Exhaust, Male BSPP Thread



Stainless steel 316L, FKM

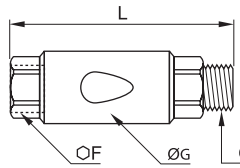

C	DN		F	G	L	kg
G1/8	10	<a href="#">4892 10 10</a>	17	22	56	0.100
G1/4	10	<a href="#">4892 13 13</a>	17	22	58	0.082
G3/8	15	<a href="#">4892 17 17</a>	22	30	75	0.191
G1/2	15	<a href="#">4892 21 21</a>	24	30	79	0.209
G3/4	20	<a href="#">4892 27 27</a>	32	42	84	0.300
G1	25	<a href="#">4892 34 34</a>	38	42	102	0.519

## 4895 Non-Return Valve, Female NPT Thread



Stainless steel 316L, FKM

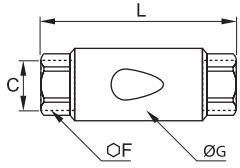

C	DN		F	G	L	kg
NPT1/8	10	<a href="#">4895 11 11</a>	17	22	50	0.083
NPT1/4	10	<a href="#">4895 14 14</a>	17	22	54	0.079
NPT3/8	15	<a href="#">4895 18 18</a>	22	30	67	0.197
NPT1/2	15	<a href="#">4895 22 22</a>	24	30	77	0.194

# Soft Start Fittings

These fittings protect your system by preventing sudden shocks. On start-up, they control the **pressure increase** in the downstream circuit; this helps **prevent the risk** of industrial accidents.

## Product Advantages

### Protection of Equipment & Personnel

- Prevents the risk of damage after any stoppage which requires the system to be vented
- Returns the control valve to its initial position in total safety
- Adjustment of the pressurisation speed
- Protects the adjustment mechanism using a recessed adjustment screw

### Mounted on FRL

- Models 7860 and 7861: yellow identification washer
- Protection for the whole system
- Simultaneous pressurisation speed of the whole system

### Mounted on Control Valve

- Models 7870 and 7871: black identification washer
- Protection of individual circuits
- Mounted on the control valve, it optimises the pressurisation speed of a specific cylinder



**Applications**

- Pneumatic Systems
- Robotics
- Textile
- Semi-Conductors
- Packaging
- Pneumatics

## Technical Characteristics

<b>Compatible Fluids</b>	Compressed air	
<b>Working Pressure</b>	3 to 10 bar	
<b>Working Temperature</b>	-15°C to +60°C	

Max. Tightening Torques	Threads	daN.m
	G1/4	1.3
G3/8	1.5	
G1/2	1.8	

Flow Characteristics	Model	Flow at 6 bar	Kv
	7860 08 13	1500 NI/min	0.80
7860 10 13	2100 NI/min	1.20	
7860 10 17	2200 NI/min	1.30	
7860 12 17	3100 NI/min	1.00	
7860 12 21	3100 NI/min	1.00	
7861 13 13	2100 NI/min	1.20	
7861 17 17	3100 NI/min	1.00	
7861 21 21	3100 NI/min	1.00	
7870 08 13	1500 NI/min	0.80	
7870 10 13	2000 NI/min	1.15	
7870 10 17	2000 NI/min	1.15	
7871 13 13	2000 NI/min	1.15	
7871 17 17	2000 NI/min	1.15	

### Component Materials

Internal seal: NBR

Adjustment screw: nickel-plated brass

Washer: technical polymer

Body: technical polymer or nickel-plated brass

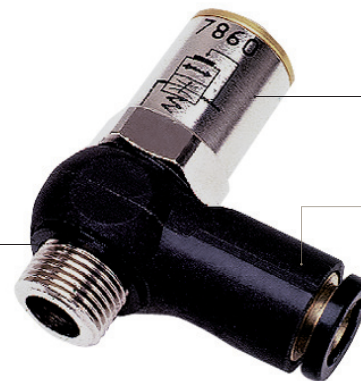

Silicone-free

### Regulations

- DI: 2002/95/CE (RoHS)
- RG: 1907/2006 (REACH)
- DI: 97/23/CE (PED)

## Operation

### Filter, Regulator, Lubricator

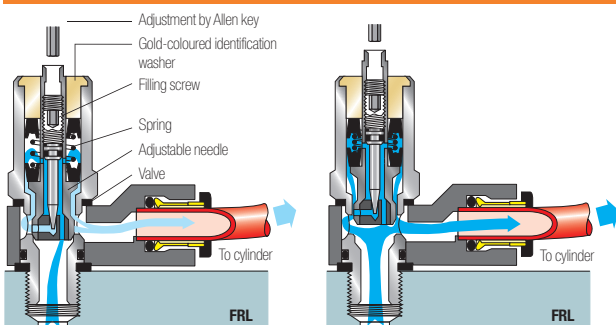



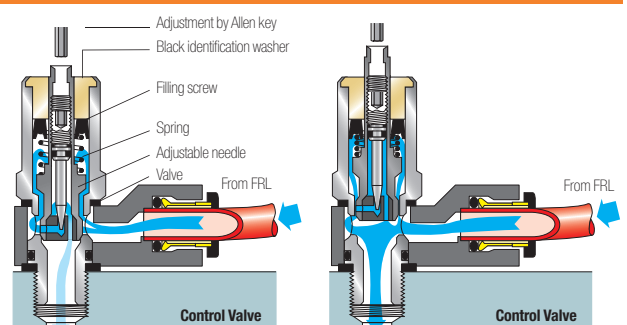



### Control Valve

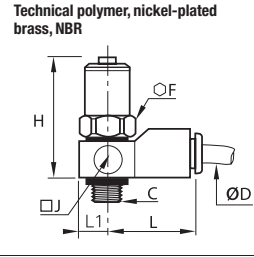



# Soft Start Fittings



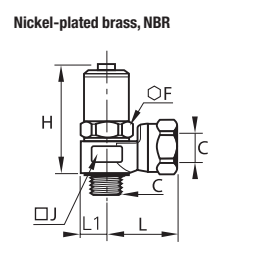

## 7860 Soft Start Fitting for Isolating Valve, Male BSPP Thread

		Technical polymer, nickel-plated brass, NBR	ØD	C		F	H <sub>min</sub>	H <sub>max</sub>	J	L	L1	kg
			8	G1/4		17	54	61	20	35	10	0.064
			10	G1/4		22	55	62	25	41	12.5	0.112
				G3/8		22	55	62	25	41	12.5	0.115
			12	G3/8		22	55	62	25	45	12.5	0.125
G1/2		22		63.5	70.5	25	45	12.5	0.152			

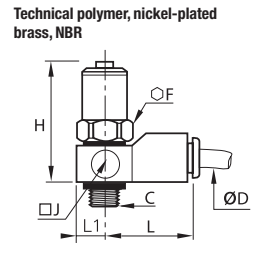

## 7861 Soft Start Fitting for Isolating Valve, Male/Female BSPP Thread

		Nickel-plated brass, NBR	C		F	H <sub>min</sub>	H <sub>max</sub>	J	L	L1	kg
			G1/4		22	54	62	24	31	12	0.147
			G3/8		22	55	62	24	31	12	0.139

## 7870 Soft Start Fitting for Control Valve, Male BSPP Thread

		Technical polymer, nickel-plated brass, NBR	ØD	C		F	H <sub>min</sub>	H <sub>max</sub>	J	L	L1	kg
			8	G1/4		17	54	61	20	35	10	0.066
			10	G1/4		22	55	62	25	41	12.5	0.114
				G3/8		22	55	62	25	41	12.5	0.117

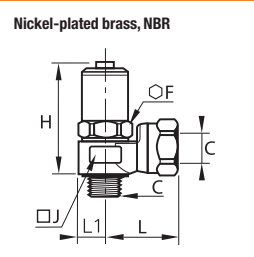
## 7871 Soft Start Fitting for Control Valve, Male/Female BSPP Thread

		Nickel-plated brass, NBR	C		F	H <sub>min</sub>	H <sub>max</sub>	J	L	L1	kg
			G1/4		22	55	62	24	31	12	0.148
			G3/8		22	55	62	24	31	12	0.141

### Adjustment of the Filling Screw

Adjusting the screw to regulate the flow of air optimises the time taken to pressurise depending on the air volume to be refilled and the system requirements.

To adjust:

- immobilise the piston using a spanner
- adjust the screw with an Allen key
  - 1.5 mm key for 8 mm diameter
  - 2.5 mm key for 10 and 12 mm diameter

Max. tightening torque: 0.1 daN.m

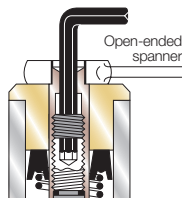

### Cylinder Pressure Cycle

When the downstream pressure reaches 2/3 of the supply pressure, full flow is automatically established

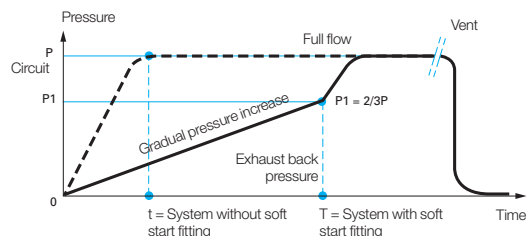

# Pneumatic Sensor Fittings

The sensor detects the pressure drop when a cylinder reaches the end of its stroke. They produce a **pneumatic or electric output signal** when the pressure drop in the exhaust chamber of the cylinder goes below their back pressure threshold.

## Product Advantages

**Easy-to-Use** | Suited to changes of series: no adjustment to position detectors is necessary

**With Pneumatic Output** | Totally pneumatic installation  
 2 possible installations:

- Supplied with permanent pressure (P1): produces a pneumatic signal when the back pressure threshold is reached
- Supplied from the control valve-cylinder circuit on the opposite side: no unexpected pneumatic signal (S) can appear during pressurisation due to the actuating pressure which supplies the sensor fitting (P1)

**With Electrical Output** | Combined electrical and pneumatic installation  
 Installation with continuous electrical supply only (BU)  
 Guarantees an electrical signal when the back pressure threshold is reached



**Applications**  
 Robotics  
 Textile  
 Semi-Conductors  
 Packaging  
 Pneumatics

## Technical Characteristics

<b>Compatible Fluids</b>	Compressed air
<b>Working Pressure</b>	3 to 8 bar
<b>Working Temperature</b>	-15°C to +60°C
<b>Back Pressure</b>	0.85 to 1 bar
<b>Switching Time</b>	Model 7818: 3 ms
<b>Open/Closed Contact</b>	Model 7828: 2A / 0-48 V 2A / 250 V 50 Hz

### Component Materials

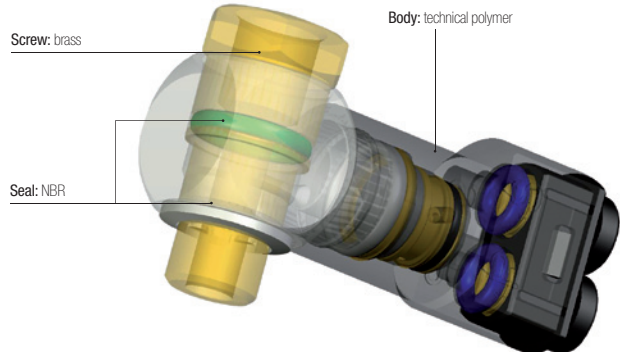

**Silicone-free**

### Regulations

DI: 2002/95/EC (RoHS)  
 RG: 1907/2006 (REACH)  
 DI: 97/23/EC (PED)

## Operation

### Pneumatic Installation Diagram

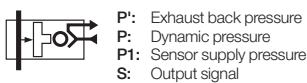

### Electrical Installation Diagram

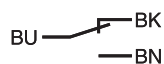

Connection via 3 core 0.5 mm<sup>2</sup> cable, 2 meters long.  
 Contactor: 5A / 250 V ~ or 5W / 48V ==

### Cylinder in Operation

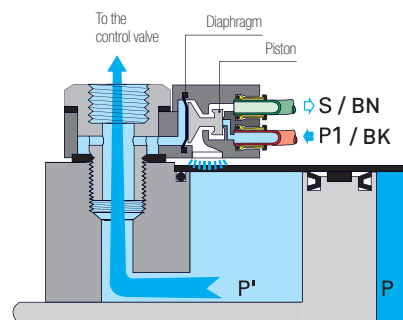

### Cylinder in Final Position

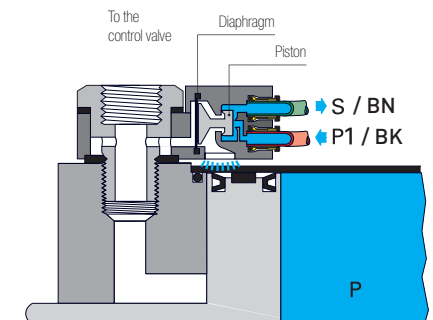

# Pneumatic Sensor Fittings

## 7818 Pneumatic Sensor Fitting, Male BSPP and Metric Thread



Technical polymer, zamak, brass, NBR

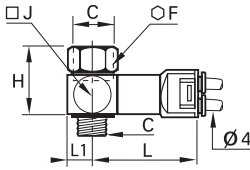

ØD	C		F	H	J	L	L1	kg
M5x0.8	7818 04 19*		8	16	11	43.5	5.5	0.025
G1/8	7818 04 10		14	23	16	44.5	8	0.043
G1/4	7818 04 13		17	28	19.5	46.5	10	0.061
G3/8	7818 04 17		22	29	23.5	49	12	0.083
G1/2	7818 04 21		27	30	31.5	52.5	16	0.125

\* Bolt zinc passivated steel

## 7818 Pneumatic Sensor, Male/Female BSPP Thread



Technical polymer, zamak, brass, NBR

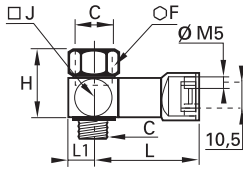

C		F	H	J	L	L1	kg
G1/8	7818 19 10	14	23	16	40.5	8	0.047
G1/4	7818 19 13	17	28	19.5	42.5	10	0.065

## 7828 Pneumatic/Electric Sensor, Male/Female BSPP and Metric Thread



Technical polymer, brass, NBR

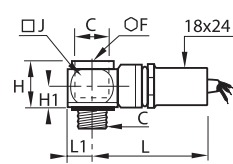

C		F	H	H1	J	L	L1	kg
M5x0.8	7828 00 19	8	20	10	11	49	5.5	0.120
G1/8	7828 00 10	6	20	10	16	52	8	0.131
G1/4	7828 00 13	8	20	10	21	54	10.5	0.145
G3/8	7828 00 17	10	22	12	28	57	14	0.182
G1/2	7828 00 21	12	26	14	33	58	16.5	0.206

### Cylinder Pressure Cycle

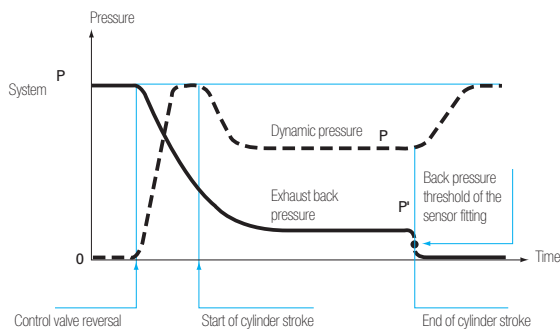

### Installation Diagram

Depending on model, S1, S2 and P1 may be pneumatic or electric. See the installation diagrams opposite.

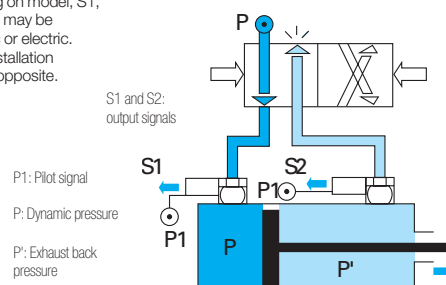

# Pressure Regulators

Parker Legris pressure regulators **stabilise at the maximum determined value** the pressure delivered to the pneumatic equipment, whatever the fluctuations of the pressure upstream.

## Product Advantages

**Ergonomics** | Easy adjustment of the output pressure through the knurled screw  
 Lockable adjustment possible  
 Output pressure adjustment options marked on the screw

**Energy Savings** | Setting of the optimum pressure enables the equipment to function correctly  
 Installation in a manifold allows optimum output pressures to be delivered to specific parts of the circuit  
 Designed for applications where cylinder force needs to be controlled: marking, sleeving, crimping cylinders etc.



Robotics  
 Textile  
 Semi-Conductors  
 Packaging  
 Pneumatics

Applications

## Technical Characteristics

<b>Compatible Fluids</b>	Compressed air		
<b>Working Pressure</b>	Upstream pressure: 1 to 16 bar Downstream pressure: 1 to 8 bar		
<b>Working Temperature</b>	-10°C to +70°C		

<b>Max. Tightening Torques</b>	Threads	G1/8	G1/4	G3/8
	daN.m	0.4	0.5	0.6

### Component Materials



### Silicone-free

### Regulations

DI: 2002/95/EC (RoHS)  
 RG: 1907/2006 (REACH)  
 DI: 97/23/EC (PED)

## Operation

### Mounting Upstream of the Control Valve

Adjustment of the piston feed pressure in both directions

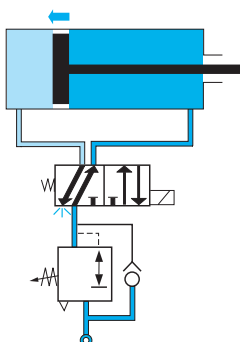

### Mounting Downstream of the Control Valve

**Phase 1:** adjustment of the piston speed in a single direction

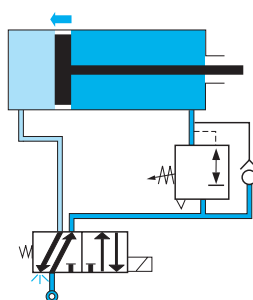

**Phase 2:** in return direction, pressure is supplied through the control valve

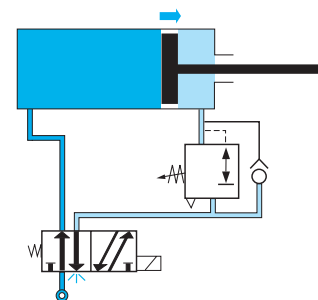

# Pressure Regulators

**7300**

Pressure Regulator, Male BSPP Thread



Technical polymer, nickel-plated brass, NBR

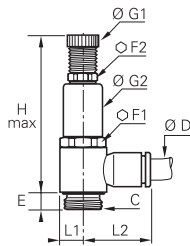

ØD	C		E	F1	F2	G1	G2	H <sub>max</sub>	L1	L2	kg
4	G1/8	<a href="#">7300 04 10</a>	4.5	17	13	14	17	65	7	18.5	0.047
	G1/8	<a href="#">7300 06 10</a>	4.5	17	13	14	17	65	7	20	0.047
6	G1/4	<a href="#">7300 06 13</a>	7.5	17	13	14	17	74.5	9.5	22	0.065
	G1/8	<a href="#">7300 08 10</a>	4.5	17	13	14	17	65	7	25	0.048
8	G1/4	<a href="#">7300 08 13</a>	7.5	17	13	14	17	74.5	9.5	27	0.066
	G3/8	<a href="#">7300 08 17</a>	8.5	22	17	18.5	22	84	11.5	28.5	0.121
10	G1/4	<a href="#">7300 10 13</a>	7.5	17	13	14	17	74.5	9.5	29	0.067
	G3/8	<a href="#">7300 10 17</a>	8.5	22	17	18.5	22	84	11.5	30.5	0.122

## Flow Characteristics at 7 bar (NI/min)

### G1/8 Models

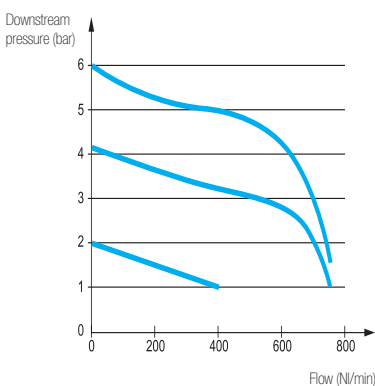

### G1/4 Models

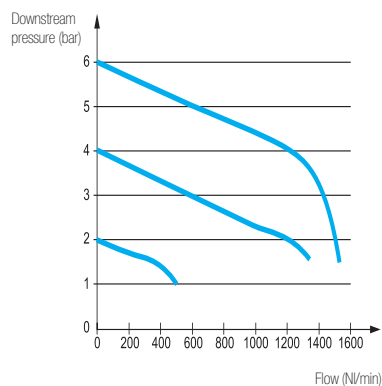

### G3/8 Models

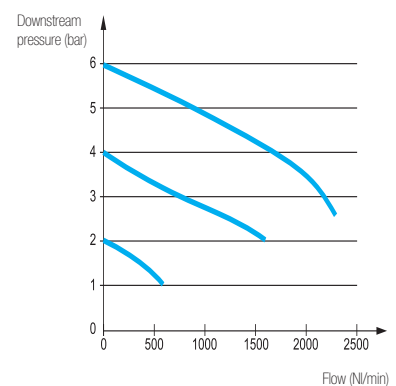

# Pressure Reducers

Parker Legris pressure reducers are designed to **set the pressure** of a compressed air circuit to a determined value. They therefore enable **energy saving** by limiting the cylinder pressure.

## Product Advantages

### Design & Performance

Optimisation of the pressure at the minimum values required to provide final force and energy consumption  
Manual adjustment protected by a plug  
Visual indication of the differential pressure by colour code

### Two Models Available

Banjo: fitted directly on the control valve or terminal block  
In-line: fitted in the pipework, between the control valve and cylinder



**Applications**  
Robotics  
Textile  
Semi-Conductors  
Packaging  
Pneumatics

## Technical Characteristics

<b>Compatible Fluids</b>	Compressed air				
<b>Working Pressure</b>	1 to 8 bar				
<b>Working Temperature</b>	-15°C to +60°C				
<b>Max. Tightening Torques for Models 7318 and 7471</b>	Threads	G1/8	G1/4	G3/8	G1/2
	daN.m	0.8	1.2	3	3.5

### Component Materials

Internal seals: NBR



Silicone-free

### Regulations

DI: 2002/95/EC (RoHS)  
RG: 1907/2006 (REACH)  
DI: 97/23/EC (PED)

## Operation

### Installation Diagram

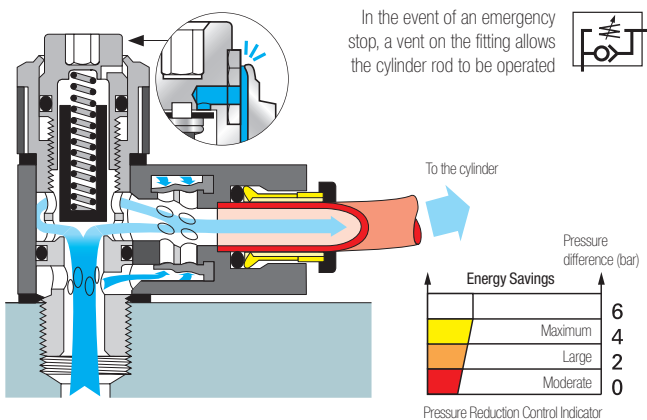

### Cylinder Pressure Cycle

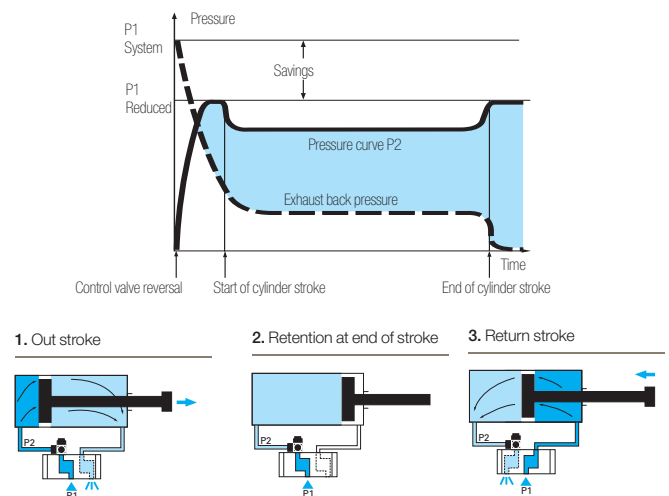

### Manual Adjustment

To ease access to the adjustment, Parker Legris has designed a plug-in manual control system.

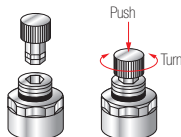

To prevent access to the setting mechanism, a sealing plug may be used.

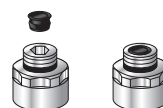

This may be removed if necessary as follows:  
1. Pierce the centre  
2. Remove the plug



# Pressure Reducers

## 7318 Banjo Pressure Reducer, Male BSPP Thread



Zamak, nickel-plated brass, NBR

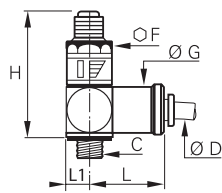

ØD	C		F	G	H <sub>min</sub>	H <sub>max</sub>	L	L1	kg
6	G1/8	<a href="#">7318 06 10</a>	19	20	49	57	43	10.5	0.137
	G1/4	<a href="#">7318 06 13</a>	19	20	49	57	43	10.5	0.137
8	G1/4	<a href="#">7318 08 13</a>	19	20	49	57	40	10.5	0.134
	G1/4	<a href="#">7318 10 13</a>	27	20	55	64	50	14	0.251
10	G3/8	<a href="#">7318 10 17</a>	27	26	55	94	50	14	0.253

## 7471 Banjo Pressure Reducer, Male/Female BSPP Thread



Zamak, nickel-plated brass, NBR

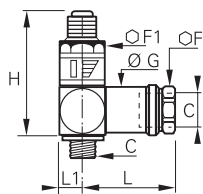

C		F	F1	G	H <sub>min</sub>	H <sub>max</sub>	L	L1	kg
G1/8	<a href="#">7471 10 10</a>	19	19	20	49	57	45	10.5	0.158
G1/4	<a href="#">7471 13 13</a>	19	19	20	49	57	45	10.5	0.149
G3/8	<a href="#">7471 17 17</a>	24	27	26	55	64	56	14	0.290
G1/2	<a href="#">7471 21 21</a>	30	30	31	75	86	63	16.5	0.502

## 7316 In-Line Tube-to-Tube Pressure Reducer



Nickel-plated brass, NBR

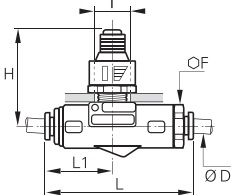

ØD		F	H <sub>min</sub>	H <sub>max</sub>	L	L1	ØT	kg
6	<a href="#">7316 06 00</a>	22	49	57	74	32	18.5	0.212
8	<a href="#">7316 08 00</a>	22	49	57	71	32	18.5	0.200
10	<a href="#">7316 10 00</a>	27	61	70	89	41	22.5	0.412

## 7416 In-Line Pressure Reducer, Female BSPP Thread



Nickel-plated brass, NBR

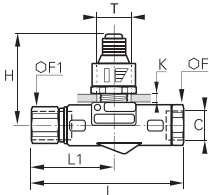

C		F	F1	H <sub>min</sub>	H <sub>max</sub>	K	L	L1	ØT	kg
G1/8	<a href="#">7416 10 10</a>	17	19	49	57	4	74	35	18.5	0.212
G1/4	<a href="#">7416 13 13</a>	17	19	49	57	4	83	44	18.5	0.214
G3/8	<a href="#">7416 17 17</a>	22	27	61	70	5	90	44	22.5	0.401
G1/2	<a href="#">7416 21 21</a>	27	30	75	86	7	119	61	22.5	0.651

## 7000 Sealing Plug for Pressure Reducer



Technical polymer



		G	kg
	<a href="#">7000 00 01</a>	8	0.001

## 7000 Manual Ratchet Control for Pressure Reducer



Nickel-plated brass, NBR

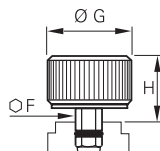

		F	G	H	kg
	<a href="#">7000 00 00</a>	6	22	15	0.040

# Snap Fittings

The snap fittings enable a **circuit to be isolated** without the need to vent the complete system. They are designed to facilitate repeated connections and disconnections in total safety.



## Product Advantages

### Performance & Safety

- Partial venting of systems while work is carried out
- Energy and time saving during maintenance operations
- Protection of individuals by maintaining pressure if necessary
- Audible click indicates connection
- Circuit identification by coloured rings (on request)

**Applications**

- Control Panels
- Robotics
- Semi-Conductors
- Packaging
- Pneumatics
- Automotive Process

## Technical Characteristics

<b>Compatible Fluids</b>	Compressed air
<b>Working Pressure</b>	0 to 10 bar
<b>Working Temperature</b>	-20°C to +80°C
<b>Flow Characteristics at 6 bar</b>	DN 5 mm: 1000 NI/min DN 7 mm: 1900 NI/min

### Regulations

- DI: 2002/95/EC (RoHS)
- RG: 1907/2006 (REACH)
- DI: 97/23/EC (PED)

### Component Materials

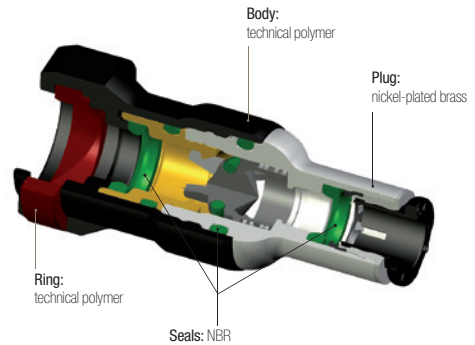

### Silicone-free

## Operation

### Circuit Closed

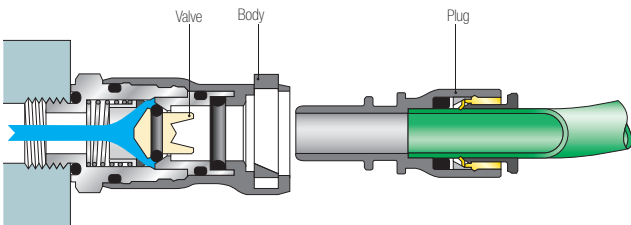

### Circuit Open

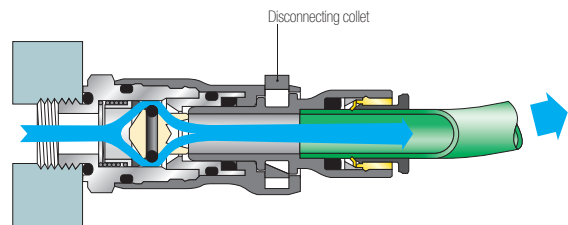

### Flow Characteristics - Pressure Drop

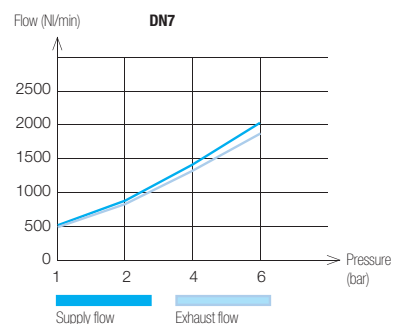
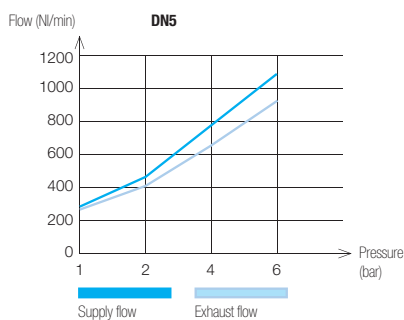

# Snap Fittings

## 7926 Body with Push-In Connection



Technical polymer, nickel-plated brass, NBR

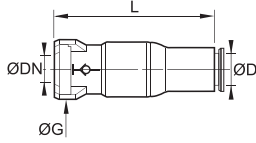

ØD	DN		G	L	kg
6	5	<a href="#">7926 05 06</a>	18.5	44	0.020
8	5	<a href="#">7926 05 08</a>	18.5	49	0.024
10	7.3	<a href="#">7926 07 10</a>	22	58.5	0.044

## 7921 Body with Male BSPP Thread



Technical polymer, nickel-plated brass, NBR

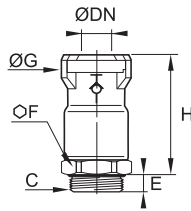

C	DN		E	F	G	H	kg
G1/8	5	<a href="#">7921 05 10</a>	5.5	16	18.5	31.5	0.022
G1/4	5	<a href="#">7921 05 13</a>	5.5	16	18.5	31.5	0.023
G1/4	7.3	<a href="#">7921 07 13</a>	5.5	20	22	37.5	0.039
G3/8	7.3	<a href="#">7921 07 17</a>	5.5	20	22	37.5	0.041

## 7960 Straight Probe, Push-In Connection



Technical polymer, NBR

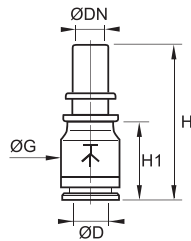

ØD	DN		G	H	H1	kg
6	5	<a href="#">7960 05 06</a>	13.5	36.5	17.5	0.007
8	5	<a href="#">7960 05 08</a>	13.5	37	18	0.003
10	7.3	<a href="#">7960 07 10</a>	16	41	20.5	0.004

## 7961 Straight Probe, Male BSPP Thread



Technical polymer, nickel-plated brass, NBR

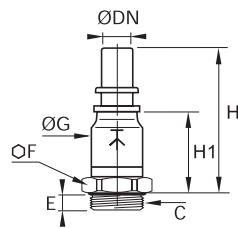

C	DN		E	F	G	H	H1	kg
G1/8	5	<a href="#">7961 05 10</a>	5.5	13	13.5	46	27	0.017
G1/4	5	<a href="#">7961 05 13</a>	5.5	16	13.5	46	27	0.019
G1/4	7.3	<a href="#">7961 07 13</a>	5.5	16	16	51.5	31	0.025
G3/8	7.3	<a href="#">7961 07 17</a>	5.5	20	16	51.5	31	0.034

# Manually-Operated Valves

Manually-operated valves offer a **reliable** and **durable** system for opening and closing the circuit when the system has to be **switched frequently**. They provide a significant reduction in the time needed to work on pneumatic circuits.

## Product Advantages

### Manual Switch-Operated Valves

Downstream control supply provided by simply moving the lever  
 2 models available to provide the best solution for the system:

- 3/2: opening, closing, venting
- 2/2: opening, closing

Compact and ergonomic (can be positioned through 360°)  
 Push-in connections

### Valves with Sliding Sleeve

Uni-directional use ensures the downstream circuit is vented  
 Operated in the plane of the tube  
 Lightweight due to the use of aluminium  
 Ideal for complex installations in a restricted space  
 Immediate identification of the venting system by the colour (red)



**Applications**

- Robotics
- Conveyors
- Textile
- Plastics Engineering
- Printing
- Pneumatics
- Packaging

## Technical Characteristics

<b>Compatible Fluids</b>	Compressed air
<b>Working Pressure</b>	0 to 10 bar Model 0669: 0 to 16 bar
<b>Working Temperature</b>	-10°C to +80°C Model 0669: -5°C to +70°C

### Component Materials

Seals: NBR

**Bolt:**  
 Manual switch-operated valve: nickel-plated brass with seal  
 Sleeve valve: nickel-plated brass

**Body:**  
 Manual switch-operated valve: technical polymer  
 Sleeve valve: nickel-plated brass

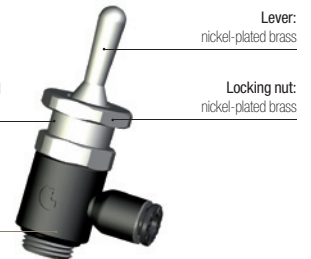

### Silicone-free

### Regulations

DI: 2002/95/EC (RoHS)  
 RG: 1907/2006 (REACH)  
 DI: 97/23/EC (PED)

## Operation

### Switch-Operated Valves



Open

Closed

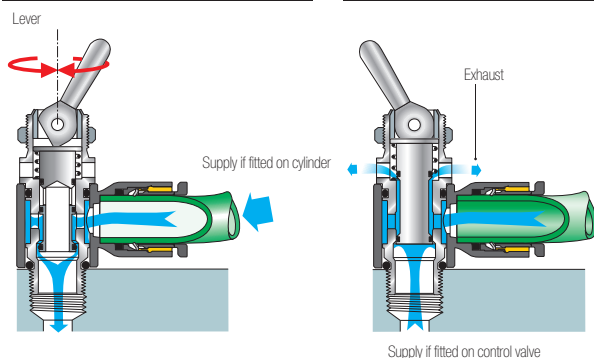

### Sleeve Valves

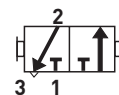

Open: downstream supply

Closed: downstream exhaust

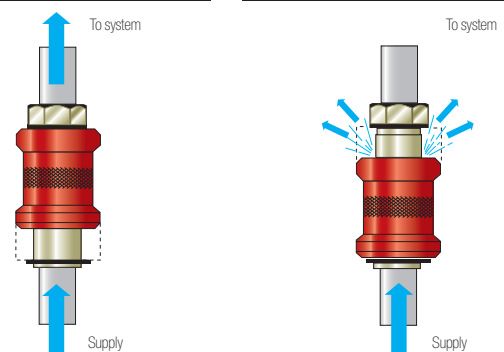

# Manually-Operated Valves

## 7800

### 3/2 Manual Switch-Operated Valve, Supply, Male BSPP and Metric Thread



Technical polymer, nickel-plated brass, NBR

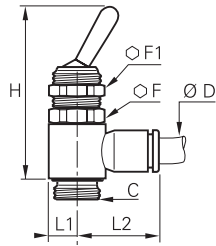

ØD	C		F	F1	H	L1	L2	kg
4	M5x0.8	<a href="#">7800 04 19</a>	14	14	42	7	18.5	0.008
	G1/8	<a href="#">7800 04 10</a>	14	14	43	7	18.5	0.022
6	M5x0.8	<a href="#">7800 06 19</a>	14	14	42	7	18.5	0.009
	G1/8	<a href="#">7800 06 10</a>	14	14	43	7	20	0.023
8	G1/4	<a href="#">7800 08 10</a>	17	14	50.5	9	22	0.048
	G1/8	<a href="#">7800 08 10</a>	14	14	43	7	25	0.023
10	G1/4	<a href="#">7800 10 13</a>	17	14	50.5	9	29	0.048

For part numbers 7800 04 19 and 7800 06 19, adaptor sealing is effected by a flat PTFE seal and tightening torque is maximum 0.16 daN.m.

## 7801

### 3/2 Manual Switch-Operated Valve, Control, Male BSPP Thread



Technical polymer, nickel-plated brass, NBR

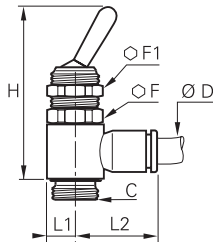

ØD	C		F	F1	H	L1	L2	kg
4	G1/8	<a href="#">7801 04 10</a>	14	14	43	7	18.5	0.023
6	G1/8	<a href="#">7801 06 10</a>	14	14	43	7	20	0.023
	G1/4	<a href="#">7801 06 13</a>	17	14	50.5	9	22	0.048
8	G1/8	<a href="#">7801 08 10</a>	14	14	43	7	25	0.026
	G1/4	<a href="#">7801 08 13</a>	17	14	50.5	9	27	0.049
10	G1/4	<a href="#">7801 10 13</a>	17	14	50.5	9	29	0.051

## 7802

### 2/2 Manual Switch-Operated Valve, Male BSPP Thread



Technical polymer, nickel-plated brass, NBR

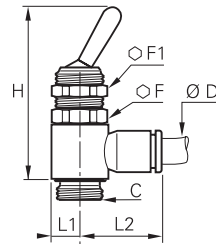

ØD	C		F	F1	H	L1	L2	kg
4	G1/8	<a href="#">7802 04 10</a>	14	14	43	7	18.5	0.023
	G1/8	<a href="#">7802 06 10</a>	14	14	43	7	20	0.024
6	G1/4	<a href="#">7802 06 13</a>	17	14	50.5	9	22	0.050
	G1/8	<a href="#">7802 08 10</a>	14	14	43	7	25	0.024
8	G1/4	<a href="#">7802 08 13</a>	17	14	50.5	9	27	0.052
	G1/4	<a href="#">7802 10 13</a>	17	14	50.5	9	29	0.052

## 0669

### 3/2 Sleeve Valve, Female BSPP and Metric Thread



Nickel-plated brass, aluminium, NBR

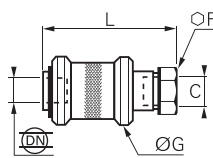

C	DN		F	G	L	kg
M5x0.8	2.5	<a href="#">0669 02 19</a>	10	14	30.5	0.012
G1/8	4	<a href="#">0669 04 10</a>	14	25	48	0.050
G1/4	7	<a href="#">0669 07 13</a>	19	30	58	0.096
G3/8	10	<a href="#">0669 10 17</a>	22	35	68	0.154
G1/2	14	<a href="#">0669 14 21</a>	27	40	75	0.210
G3/4	19	<a href="#">0669 19 27</a>	32	50	83	0.324

# Metal Quick Exhaust Valves

This range of metal quick exhaust valves is offered in nickel-plated brass, aluminium and stainless steel. These valves, which are suitable for **any environment**, increase the **return speed** of the cylinder rod by allowing the exhaust to pass directly to atmosphere.

## Product Advantages

**Time Saving & Compact** | Reduction in cycle times: return speed improved  
 Dimensions optimised for space reduction  
 Exhaust silencer incorporated on some models  
 Excellent exhaust capacity  
 Robust

**Nickel-Plated Brass or Stainless Steel** | Ideal for applications in restrictive environments  
 Orientation as required  
 Many installation options and choice of silencer  
 Designed without retention areas to optimise frequent cleaning operations (stainless steel)

**Aluminium** | Protection of individuals through low noise emissions  
 Lightweight and robust  
 Silencer integrated for greater compactness



**Applications**  
 Robotics  
 Conveyors  
 Textile  
 Plastics Engineering  
 Printing  
 Pneumatics  
 Packaging

## Technical Characteristics

<b>Compatible Fluids</b>	Compressed air
<b>Working Pressure</b>	<b>7970:</b> 0.7 to 10 bar <b>7971 and 7899:</b> 2 to 10 bar
<b>Working Temperature</b>	<b>7970:</b> -20°C to +70°C <b>7971:</b> -10°C to +70°C <b>7899:</b> Threads G1/8 and G1/4: -10°C to +120°C Threads G3/8 to G1: -20°C to +180°C

### Component Materials

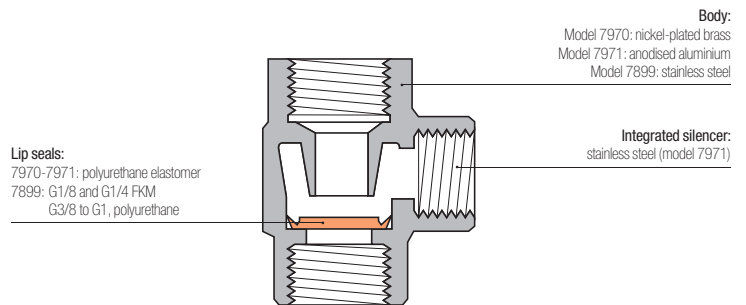

**Silicone-free**

### Regulations

DI: 2002/95/EC (RoHS)  
 RG: 1907/2006 (REACH)  
 DI: 97/23/EC (PED)

## Operation

### Mounted on Cylinder

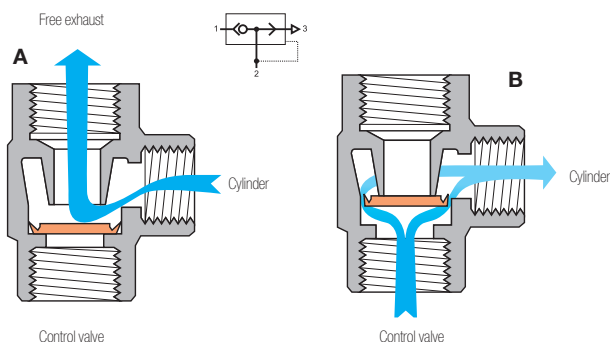

### Installation Diagram

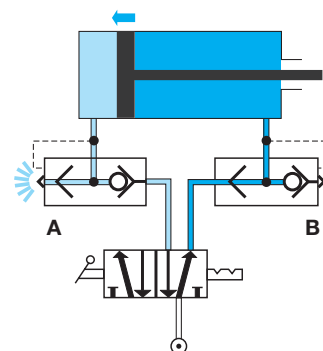

# Metal Quick Exhaust Valves

## 7970

### Elbow Quick Exhaust Valve, Female BSPP and Metric Thread



Nickel-plated brass

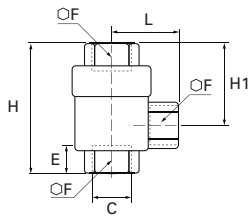

C		E	F	H	H1	L	kg
M5x0.8	<a href="#">7970 19 19</a>	5	10	24.8	15.6	4	0.028
G1/8	<a href="#">7970 10 10</a>	7.5	14	42	28	8	0.084
G1/4	<a href="#">7970 13 13</a>	11	19	53	34.5	11	0.146
G3/8	<a href="#">7970 17 17</a>	12	21	58	36	12	0.149
G1/2	<a href="#">7970 21 21</a>	14	26	71	44	14	0.314
G3/4	<a href="#">7970 27 27</a>	16	32	86	52	18	0.449
G1	<a href="#">7970 34 34</a>	19	38	94	56	19	0.530

Noise level:  
7971 10 10 : 70 dBa  
7971 13 13 : 70 dBa  
7971 17 17 : 72 dBa  
7971 21 21 : 88 dBa

## 7971

### Elbow Quick Exhaust Valve, Male BSPT/Female BSPP Thread



Treated aluminium

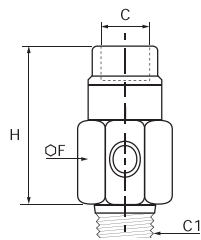

C	C1		F	H	kg
G1/8	R1/8	<a href="#">7971 10 10</a>	18	51	0.013
G1/4	R1/4	<a href="#">7971 13 13</a>	18	49	0.018
G3/8	R3/8	<a href="#">7971 17 17</a>	27	56	0.048
G1/2	R1/2	<a href="#">7971 21 21</a>	34	70	0.086

## 7899

### Quick Exhaust Valve, Female BSPP Thread



Stainless steel 316L

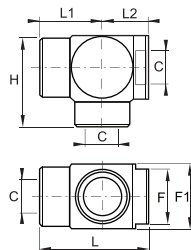

C	DN		F	F1	H	L	L1	L2	kg
G1/8	7	<a href="#">7899 00 10</a>	17	22	31.5	37.5	21	16.5	0.097
G1/4	7	<a href="#">7899 00 13</a>	17	22	31.5	37.5	21	16.5	0.083
G3/8	9	<a href="#">7899 00 17</a>	22	26	37	44.5	25.5	19	0.139
G1/2	12	<a href="#">7899 00 21</a>	27	32	45	54	31	23	0.240
G3/4	18	<a href="#">7899 00 27</a>	38	46	65	79	44	35	0.795
G1	18	<a href="#">7899 00 34</a>	38	46	65	79	44	35	0.674

To complement our exhaust valves 7970 and 7899, you will find a full range of silencers on the following pages.

# Silencers

Silencers are designed for installation on exhaust circuits **to reduce the noise levels** of equipment while operating, thus improving user comfort.

## Product Advantages

### Variety of Applications

- 2 versions incorporating flow control regulation
- Extremely compact models available
- Polyethylene: excellent balance between exhaust flow rate and noise reduction
- Sintered bronze: robust and economic
- 316L stainless steel: increased chemical resistance and mechanical strength



Applications

- Robotics
- Textile
- Semi-Conductors
- Packaging
- Pneumatics

## Technical Characteristics

<b>Compatible Fluids</b>	Compressed air
<b>Working Pressure</b>	Polyethylene: 0 to 10 bar Sintered bronze: 0 to 12 bar 316L stainless steel: 0 to 12 bar
<b>Working Temperature</b>	Polyethylene: -10°C to +80°C Sintered bronze: -20°C to +150°C 316L stainless steel: -20°C to +180°C

### Component Materials

**Body:**  
 brass (0670-0673-0675-0671-0677-0672)  
 polymer (0674-0676)  
 stainless steel (0682-0683)

**Silencer:**  
 sintered bronze (0670-0673-0675-0671-0677-0672)  
 polymer (0674-0676)  
 316L stainless steel (0682-0683)

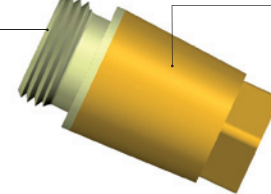

Silicone-free

### Regulations

- DI: 2002/95/EC (RoHS)
- RG: 1907/2006 (REACH)
- DI: 97/23/EC (PED)
- DI: 2003/10/EC (Noise Directive)
- Requirement to use ear protection if exposure > 8 hours (85 dBA)
- RG: 1910.95(b) (OSHA)
- Requirement to use ear protection if exposure > 8 hours (90 dBA)



### Flow and Noise Levels for Silencers 0672 and 0676

0672	Number of Turns						Noise Level in dBA at 6 bar and 350 NI/min
	0	1	2	3	4	5	
0672 00 10	0	200	600	740	-	-	81
0672 00 13	0	300	650	1280	-	-	82
0672 00 17	0	450	950	1300	1500	-	83
0672 00 21	0	830	1430	1800	2100	2220	83

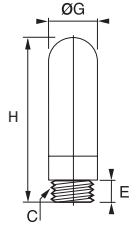

0676	Number of Turns										Noise Level in dBA at 6 bar and 350 NI/min
	0	1	2	3	4	5	6	7	8	9	
0676 00 10	0	30	90	210	335	370	390	390	395	395	82
0676 00 13	0	22	25	50	340	750	940	980	1000	1025	84
0676 00 19	0	22	69	97	125	143	-	-	-	-	81
0676 00 17	0	518	1147	1716	2153	2571	2823	2930	-	-	85
0676 00 21		814	1849	2880	4087	5044	5236	-	-	-	86

# Silencers

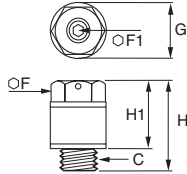

## 0674 Polymer Silencer, Male BSPP and Metric Thread

	<p>Technical polymer</p> 	<b>C</b>		<b>E</b>	<b>G</b>	<b>H</b>	<b>kg</b>
		M5x0.8	<a href="#">0674 00 19</a>	4	6.5	23	0.003
		G1/8	<a href="#">0674 00 10</a>	6	12.5	34	0.002
		G1/4	<a href="#">0674 00 13</a>	7	15.5	42.5	0.003
		G3/8	<a href="#">0674 00 17</a>	11.5	18.5	67.5	0.007
		G1/2	<a href="#">0674 00 21</a>	11	23.5	78	0.010
		G3/4	<a href="#">0674 00 27</a>	15.5	38.5	131	0.035
		G1	<a href="#">0674 00 34</a>	19.5	49	160	0.056

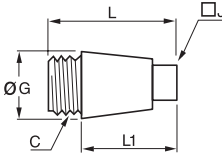

## 0676 Flow Control Polymer Silencer, Male BSPP and Metric Thread

	<p>Technical polymer</p> 	<b>C</b>		<b>F</b>	<b>F1</b>	<b>G</b>	<b>H</b>	<b>H1</b>	<b>kg</b>
		M5x0.8	<a href="#">0676 00 19</a>	8	1.5	9.2	16	11	0.008
		G1/8	<a href="#">0676 00 10</a>	13	2.5	15	20.5	14.5	0.003
		G1/4	<a href="#">0676 00 13</a>	15	4	18	29	22	0.007
		G3/8	<a href="#">0676 00 17</a>	20	6	24	38	30	0.018
		G1/2	<a href="#">0676 00 21</a>	25	8	30	50	40	0.045

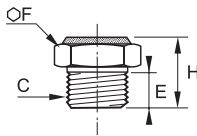

## 0670 Threaded Silencer, Male BSPP Thread

	<p>Sintered bronze, brass</p> 	<b>C</b>		<b>G</b>	<b>J</b>	<b>L</b>	<b>L1</b>	<b>kg</b>
		G1/8	<a href="#">0670 00 10</a>	12	7	22	17	0.007
		G1/4	<a href="#">0670 00 13</a>	15	9	27	21	0.015
		G3/8	<a href="#">0670 00 17</a>	19	11	35	28	0.028
		G1/2	<a href="#">0670 00 21</a>	23	13	43	34	0.049
		G3/4	<a href="#">0670 00 27</a>	30	17	55	45	0.091
		G1	<a href="#">0670 00 34</a>	37	21	65	53	0.152

## 0673 Compact Silencer, Male BSPP and Metric Thread

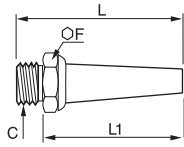

	<p>Sintered bronze, brass</p> 	<b>C</b>		<b>E</b>	<b>F</b>	<b>H</b>	<b>kg</b>
		M5x0.8	<a href="#">0673 00 19</a>	4	7	8	0.001
		G1/8	<a href="#">0673 00 10</a>	8	14	14	0.008
		G1/4	<a href="#">0673 00 13</a>	8	17	14	0.012
		G3/8	<a href="#">0673 00 17</a>	10	22	18	0.020
		G1/2	<a href="#">0673 00 21</a>	12	27	21	0.042

## 0675 Threaded Silencer, Male BSPP and Metric Thread

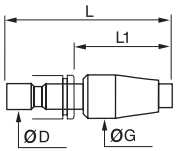

	<p>Sintered bronze, brass</p> 	<b>C</b>		<b>F</b>	<b>L</b>	<b>L1</b>	<b>kg</b>
		M5x0.8	<a href="#">0675 00 19</a>	7	16	12	0.002
		M7x1	<a href="#">0675 00 55</a>	11	25	19	0.005
		G1/8	<a href="#">0675 00 10</a>	14	42	34	0.014
		G1/4	<a href="#">0675 00 13</a>	17	52	44	0.022
		G3/8	<a href="#">0675 00 17</a>	22	54	44	0.037
		G1/2	<a href="#">0675 00 21</a>	27	65	53	0.072

# Silencers

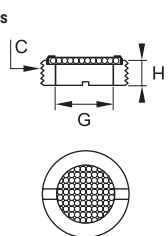

## 0671 Push-In Silencer

	Sintered bronze, nickel-plated brass 	<b>ØD</b>		<b>G</b>	<b>L</b>	<b>L1</b>	<b>kg</b>
		4	<a href="#">0671 04 00</a>	13	41.5	24.5	0.015
		6	<a href="#">0671 06 00</a>	15	48	29	0.024
		8	<a href="#">0671 08 00</a>	15	49.5	29.5	0.025
		10	<a href="#">0671 10 00</a>	19.5	68	43.5	0.052
		12	<a href="#">0671 12 00</a>	20	68.5	43	0.052

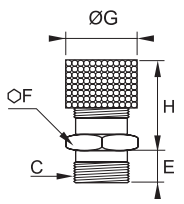

## 0677 Miniature Silencer, Male BSPP Thread

	Brass 	<b>C</b>		<b>G</b>	<b>H</b>	<b>kg</b>
		G1/8	<a href="#">0677 00 10</a>	6	6	0.002
		G1/4	<a href="#">0677 00 13</a>	8	6	0.003
		G3/8	<a href="#">0677 00 17</a>	11	7	0.006
		G1/2	<a href="#">0677 00 21</a>	14	8	0.010
		G3/4	<a href="#">0677 00 27</a>	19	11	0.019
		G1	<a href="#">0677 00 34</a>	25	10	0.025

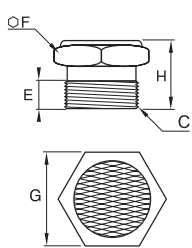

## 0672 Flow Control Silencer, Male BSPP Thread

	Sintered bronze, nickel-plated brass 	<b>C</b>		<b>E</b>	<b>F</b>	<b>G</b>	<b>H min</b>	<b>H max</b>	<b>kg</b>
		G1/8	<a href="#">0672 00 10</a>	8	14	14	17	21	0.017
		G1/4	<a href="#">0672 00 13</a>	8	17	17	20	24	0.029
		G3/8	<a href="#">0672 00 17</a>	10	22	22	20	28	0.058
		G1/2	<a href="#">0672 00 21</a>	12	27	27	28	37	0.094

## 0682 Compact Silencer, Male BSPP Thread

	Stainless steel 316L 	<b>C</b>		<b>E</b>	<b>F</b>	<b>G</b>	<b>H</b>	<b>kg</b>
		G1/8	<a href="#">0682 00 10</a>	8	7	14	15	0.007
		G1/4	<a href="#">0682 00 13</a>	8	7	17	15	0.011
		G3/8	<a href="#">0682 00 17</a>	10	8	22	18	0.019
		G1/2	<a href="#">0682 00 21</a>	12	10	27	22	0.038
		G3/4	<a href="#">0682 00 27</a>	15	12	32	27	0.063
		G1	<a href="#">0682 00 34</a>	18	14	38	32	0.117

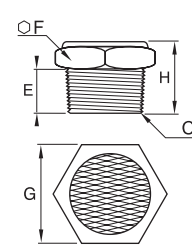
## 0683 Compact Silencer, Male NPT Thread

	Stainless steel 316L 	<b>C</b>		<b>E</b>	<b>F</b>	<b>G</b>	<b>H</b>	<b>kg</b>
		NPT1/8	<a href="#">0683 00 11</a>	7	7	14	14	0.007
		NPT1/4	<a href="#">0683 00 14</a>	11	7	17	18	0.014
		NPT3/8	<a href="#">0683 00 18</a>	11	8	22	19	0.021
		NPT1/2	<a href="#">0683 00 22</a>	15	10	27	25	0.043

